

ReTurn7600

SystemRoMedic™



Service manual - English

Art. no.

7600

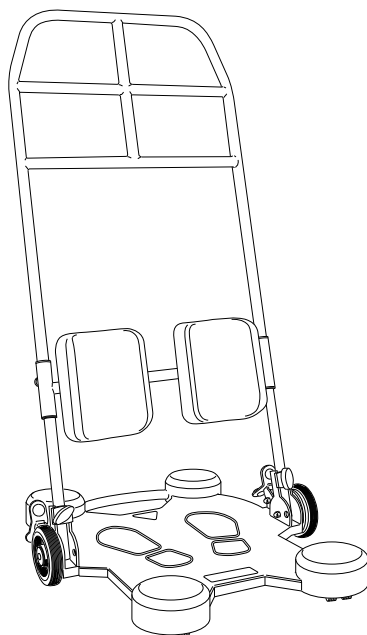

SWL: 205kg/450 lbs



Functional inspection

Visual inspection

Check the condition and function of the product regularly. Check to ensure that material is free from damage. If there are signs of wear, the product must be inspected and serviced.



Always read the manual

Always read the manuals for all assistive devices used during a transfer.

Keep the manual where it is accessible to users of the product.

Do not leave the patient unattended during a transfer situation.

The product should be inspected yearly, and otherwise as required, by a qualified technician. Service must be performed by a qualified technician.

Table of contents

Assembly	3
General	3
Exploded view	4-5
Rising ladder and leg support with component list	4
Chassie with component list	5
Spare parts	6-9
Spare part list	6-7
Replacing spare parts	8-9
Periodic inspection	10-14
Detail descriptions for Periodic inspection	10
Periodic inspection, instruction	11-14
Care of the product	15
Technical specifications	15

Assembly

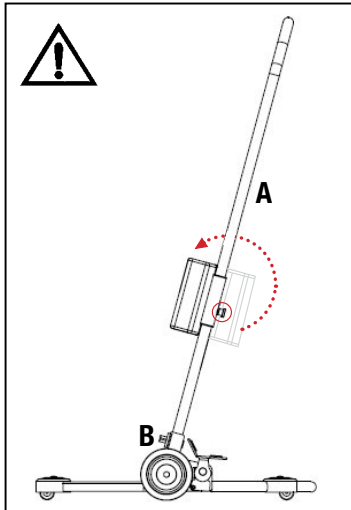

A. Push the raising ladder/tube down into the mounting fixture on the base plate, so that the height-adjustment buttons are facing towards the caregiver.

B. Insert the wing handles and tighten. Check to ensure that the wing handles are securely tightened before using the ReTurn.

General

Before the product is used, check to ensure that the screws are securely tightened. The product must be inspected regularly by an authorized technician. The product must be inspected thoroughly at least once each year, or more regularly if it is used very frequently. Inspection and service must be performed by an authorized technician.

Exploded view - Rising ladder and leg support

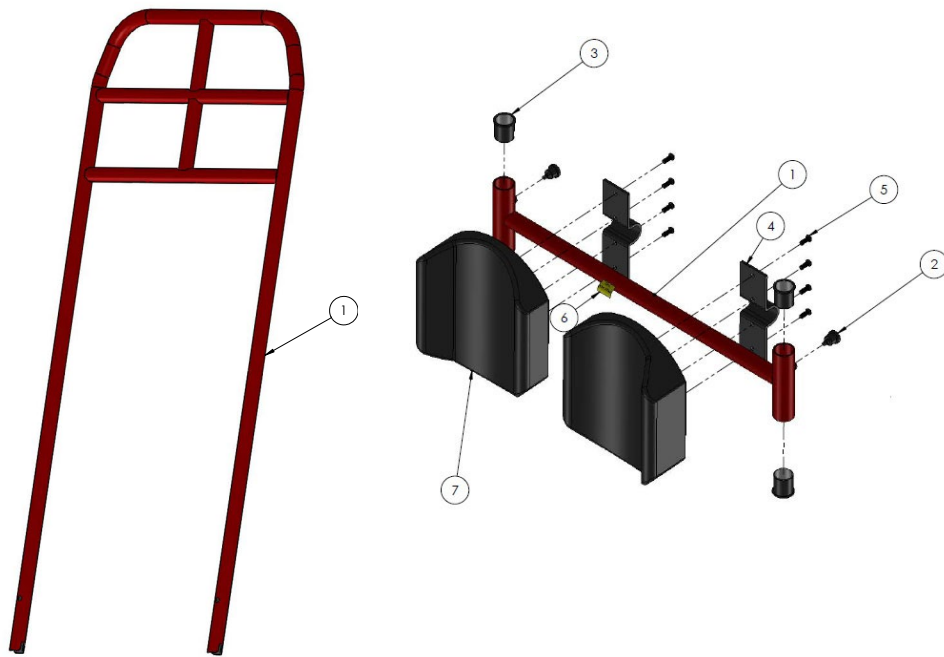

Components

Ladder:

Number	Name
1	Raising ladder

Leg support:

Number	Name	Size
1	Holder for leg support	
2	Locking pin	
3	Bushing	Ø28/Ø25,5x32 mm svart POM
4	Mounting fixture for leg support	
5	Screw K6S ISO 7380	M6x16
6	Label SWL	
7	Leg support	



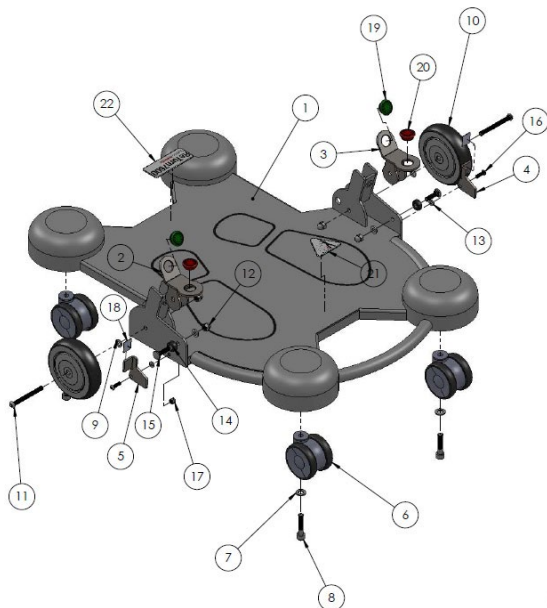







Exploded view - Chassie





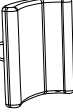

Components

Number	Name	Size
1	Base plate	
2	Brake pedal left	
3	Brake pedal right	
4	Brake shoe right	
5	Brake shoe left	
6	Castors Tente UAP 75	
7	Washer Din 125	M10 fzb
8	Screw Din 912	M10x45 fzb
9	Washer	Ø16/Ø8,2x2 mm vit POM
10	Center castors, Tente UAP	125 mm
11	Screw Din 24015 8,8	M8x80s22 fzb
12	Nut MHM Din 1587	M8 fzb
13	Washer	Ø16/Ø8x1,5 mm
14	Washer	Ø20/Ø10x9 mm svart POM
15	Screw MVBF Din 603	M8x30 fzb
16	Screw K6S ISO 7380	M6x20
17	Nut DIN985	M6 fzb
18	Brake shoe antislip	
19	Brake pad green	
20	Brake pad red	
21	Instruction label	
22	Label ReTurn7600	

Spare parts - Spare part list

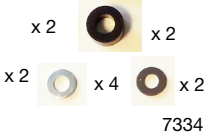
Article no.	Product	Unit	Components	Images
7332	Castors 125mm	1 set	2 x Castor 125mm 2 x Washer 2 x Screw 2 x Nut	 7332
7318-10	Brake pads red	1 set	10 x Brake pads red	 x 10 7318
7319-10	Brake pads green	1 set	10 x Brake pads green	
7322	Wing handles	1 set	10 x Wing handle M8x40 10 x Catch for Wing handle	 x 10  x 10 7322
7320	Stop for Wing handle	1 pce	1 x Catch for Wing handle	 7320
7321	Wing handle (old version) S/N before xxxxxxxxx500001	1 pce	1 x Wing handle	 7320
7333	Leg support kit	1 set	1 x Leg support 2 x Mounting fixture for leg support 8 x Screw for bracket M6x16	 7333
7331	Castor swivel 75mm	1 set	4 x Castor swivel 75mm 4 x Screw 4 x Locking nut 4 x Washer	 7331
7326	Locking pins	1 set	10 x Locking pin for leg support	 x 10 7326
7327	Instruction label	1 set	10 x Instruction label	 x 10 7327
7328	Brake shoe antislip 0,9 mm	1 set	10 x Brake shoe antislip 0,9	
7329	Brake shoe antislip 1,5 mm	1 set	10 x Brake shoe antislip 1,5	
7330	Brake kit L and R	1 set	1 x Brake pedal left 1 x Brake pedal right 1 x Brake shoe left 1 x Brake shoe right 2 x Nut MHM Din 1587 M8fzb 2 x Spring washer 2 x Carrier bolt 2 x Washer black 2 x Washer white M8 2 x Screw M6x20 2 x Washer white M6 2 x Nut Din 985 M6fzb 2 x Green plastic button 2 x Red plastic button 2 x Friction 3M tape	 x 2 7330

Spare part list

Article no.	Product	Unit	Components	Images
7334	Carriage bolt / washers	1 set	2 x Carriage bolt M8x35 2 x Teflon coated washer 4 x Steel washer 2 x Locking acorn nut DIN 986 2 x Washer black	 <p> x 2  x 2 x 2  x 4  x 2 7334 </p>

Replacing spare parts

Centre wheel

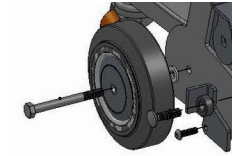

Loosen the nut and remove the screw. Install the new wheel, placing the washer between the wheel and the chassis. Insert the screw and secure it with the nut.

Brakepads, red/green

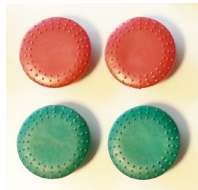

Remove the old brakepads and insert the new ones.

Wing handles and stop for wing handles



Unscrew the wing knobs and replace them with new ones. If the “stop plate” needs to be replaced, remove it and replace it with a new one.

Lower-leg support

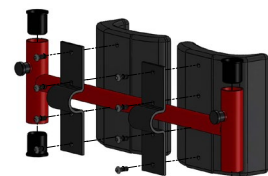

Unscrew the lower-leg support from its mount. Remove the lower-leg support and mount, and then install and secure the new ones. The lower-leg support is secured with 4 screws, which are included in the spare parts kit.

Swivel wheel



Loosen the bolt underneath the swivel wheel, remove it, and then replace all of the parts for the swivel wheel assembly. Install the new swivel wheel in the following order: wheel, washer, bolt.

Locking pin



Remove the plastic on the locking pin and loosen the nut underneath. The nut forms a unit with the locking pin, so that when it is loosened, the locking pin is also removed. Secure the new locking pin and tighten the nut.

Antislip brake shoe

For assembly instructions, see page 12 under the Periodic Inspection section.

Brake kit

For assembly instructions, see page 13 under the Periodic Inspection section.

Carriage bolt / washers

For assembly instructions, see page 12 under the Periodic Inspection section.

Periodic inspection

Detail descriptions for Periodic inspection

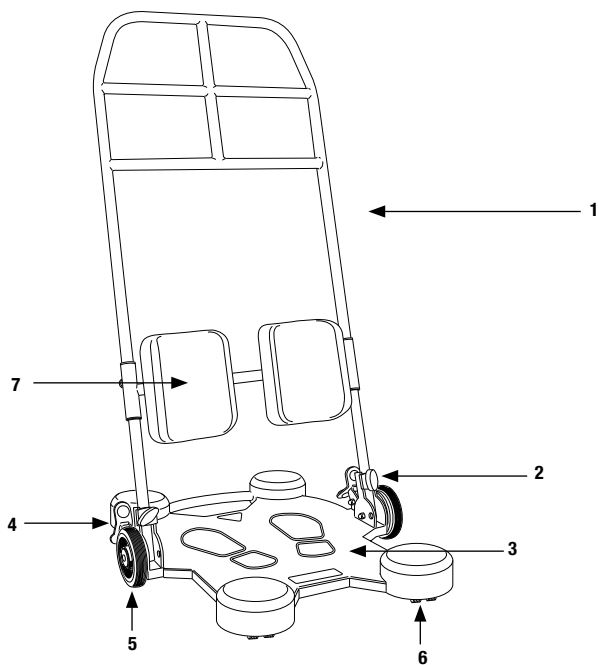

- | | |
|---|---------|
| 1. Raising ladder | Page 8 |
| 2. Wing handles | Page 8 |
| 3. Base plate | Page 8 |
| 4. Brakes (on fixed wheels) | Page 9 |
| 5. Fixed castors 125mm and axles (2 pcs.) | Page 9 |
| 6. Castors 75mm (4 pcs.) | Page 10 |
| 7. Leg support | Page 10 |

Periodic inspection, instruction

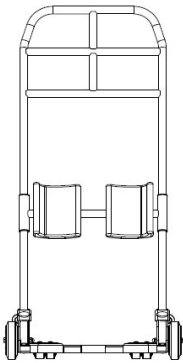

Raising ladder

Check to ensure that there is no visible damage to the raising ladder and that it is securely mounted in the base plate.

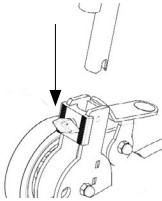

Wing handles

Mount the ladder on the base plate and ensure that both wing handles between the ladder and undercarriage (2 pcs.) are securely tightened.

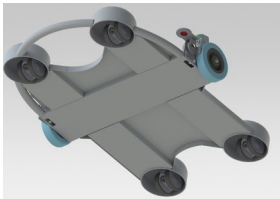

Base plate

Turn the ReTurn around and check to ensure that all parts are securely in place.



The gap between the front and rear wheels should be between 2-3 mm.

Park the ReTurn on a level surface and place a 2 mm washer under one of the castor wheels. The gap can be adjusted with the help of spacers on the castors.

Brakes

1. Remedial measures to improve brake function:

If braking effect is inadequate, the brake shoes can be switched; alternatively, a strip of anti-slip tape can be applied to the brake shoe to improve brake function.

Anti-slip is available in two thicknesses: 0.9mm and 1.5mm.

Name of spare part: Brake shoe anti-slip 0.9 mm, Art. No.: 7328

Name of spare part: Brake shoe anti-slip 1.5mm, Art. No.: 7329

Unit: 10 pcs.

Application of anti-slip tape

Note! The ladder should be removed first.

- Unscrew the brake shoe, or remove the wheel to access the brake shoe surface, and then apply the anti-slip tape to the brake shoe.

- Check brake function by ensuring that the brake shoe pressure is adequate when the brake is applied, and that the wheel moves freely when the brake is released. If the brake shoe is not tightened sufficiently, it may fall down and lock the wheel.

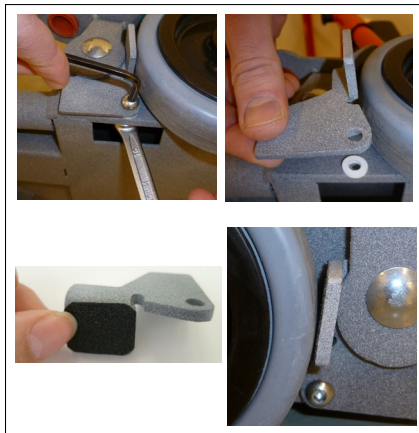

2 To prevent brake pedal from tipping automatically to braking position:

If the brake pedal fails to remain in the raised position, even when the carriage bolt is adjusted, the plastic washer can be replaced with a steel washer and a Teflon washer to increase tension on the brake pedal. These are placed between the brake yoke and the chassis. If the washers are replaced, a longer carriage bolt must also be used. (See order of assembly of parts, below.)

Name of spare part: Carriage bolt/washers, Art. No. 7334

Assembly of washers and carriage bolt

Note! The ladder should be removed first.

Remove the carriage bolt from the brake pedal and replace it with the longer carriage bolt; place the washers between the brake yoke and the chassis. Ensure that the Teflon side is against the steel washer. The steel washer must be turned so that the round side is against the Teflon washer. Insert the plastic bushing between the pedal's yoke and the chassis. Insert the carriage bolt from the outside. Tighten the locking nut, together with the accompanying steel washer, sufficiently to allow the right degree of tension on the pedal when the brake is applied and released.

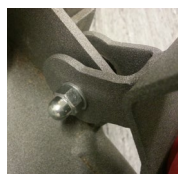
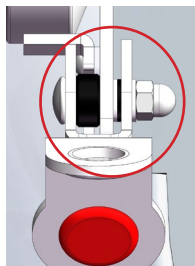

Order of assembly for parts
(marked area)

3. To improve braking effect and prevent brake pedal from tipping automatically to braking position:

If the brakes do not brake sufficiently and the brake pedal tips automatically to the braking position, the entire brake system should be replaced with a brake kit. This applies if it is not possible to remedy the problem by lightly tightening the nut.

Name of spare part: Brake kit H & V, Art. No.: 7330



Assembly of brake kit

Note! The ladder should be removed first.

1. Loosen the nut and remove the brake pedal.
2. If the pedal's yoke is bent inward, try to bend it back to straighten it.
3. Use a tool, for example, a hex key, to hold the steel washer and Teflon washer in place. Ensure that the Teflon side is against the steel washer. The steel washer must be turned so that the round side is against the Teflon washer.
4. Install the pedal and hold the washers in place using the tool. Insert the plastic bushing between the pedal's yoke and the chassis, and then insert the tool to hold it in place.
5. Insert the carriage bolt from the underside (the side with the square hole on the brake yoke) while at the same time drawing out the tool.
6. Tighten the locking nut, together with the accompanying steel washer, sufficiently to allow the right degree of tension on the pedal when the brake is applied and released.

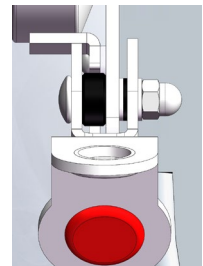
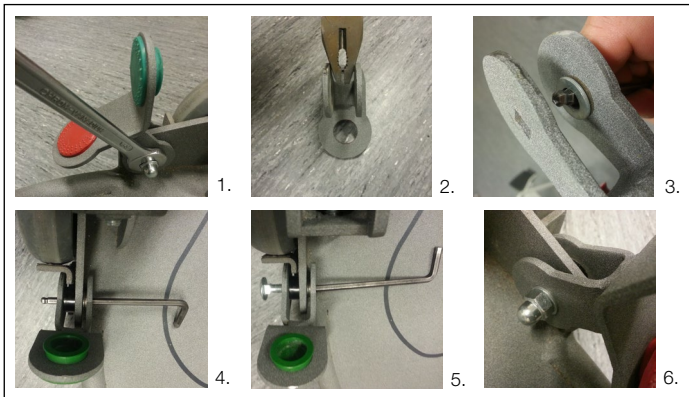

Order of assembly for parts

Brake pedal

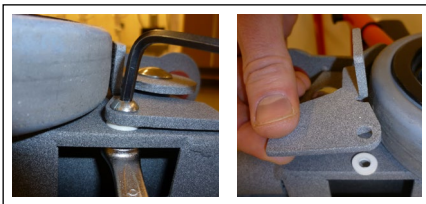

Brake shoe

Castor/castor swivel

Check to ensure that the castor wheel bolts are securely tightened and that the castors (4 pcs.) rotate and swivel easily. If necessary, remove dirt and hair from wheels.

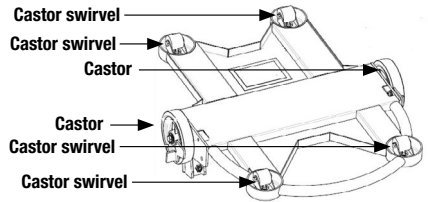

Leg support

Check both parallel and horizontal adjustment.

Friction can be adjusted by loosening or tightening the bolts at the rear of the support.

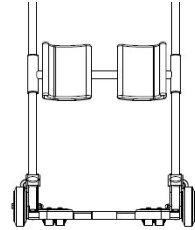

Care of the product:

- Use a soft cloth and mild cleaning agent such as dishwashing liquid or car shampoo to clean the ReTurn. Do not use abrasive cloths or brushes to clean the base plate.
- Do not use solvents.
- To disinfect, use 70% alcohol.

Technical specifications

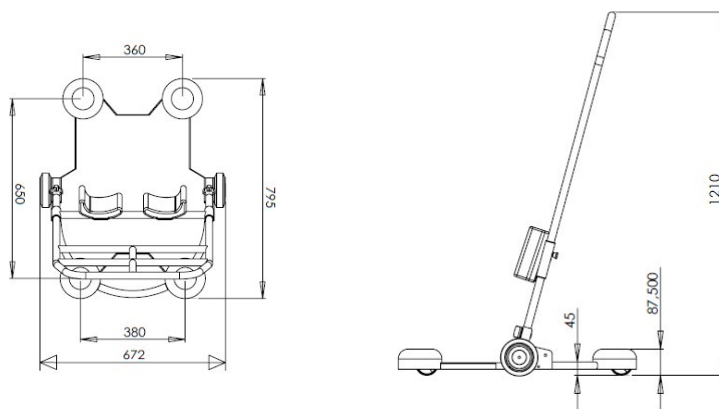

- Art.nr 7600 Complete ReTurn
- 7601 Ladder to 7600

SWL, Max weight: 200 kg/440 lbs (static load)

Total weight: 26 kg/57 lbs

Patented

Simple solutions for great results

SystemRoMedic™ is the name of Handicare's unique easy transfer concept, the market's widest and most comprehensive range of clever, easy-to-use and safe transfer and lifting aids designed to make life easier, both for the user and for the caregiver. SystemRoMedic™ is a complete solution that provides for the majority of patient transfer or manual handling requirements. From the simplest to the most complex scenarios, from the lightest to the heaviest. The concept encompasses assistive devices for four different categories of transfers:

- Transfer, assistive devices for manual transfers of users between two locations.
- Positioning, assistive devices for manual repositioning of users within the same location.
- Support, assistive devices for mobility support e.g., during sit-to-stand or gait training.
- Lifting, assistive devices for manual and mechanical lifting of users.

Improved work environment, improved quality of care and cost savings

The philosophy behind SystemRoMedic™ is focused on the prevention and reduction of occupational injuries while allowing users to experience a greater sense of independence and dignity. Through a unique combination of training and a complete range of efficient transfer aids, SystemRoMedic™ offers improvement of both work environment and quality of care and, at the same time, achieves significant cost savings.

Always make sure that you have the correct version of the manual

The most recent version of all manuals are available for downloading at/from our website; www.handicare.com.

For questions about the product and its use

Please contact your local Handicare and SystemRoMedic™ representative. A complete list of all our partners with their contact details can be found on our website; www.handicare.com.

Handicare offers solutions and support to increase the independence of disabled or elderly people as well as to improve the convenience of those who are caring for them.

The Handicare Group is one of the leading healthcare companies in Europe with its own manufacturing organizations and sales companies in Norway, Sweden, Denmark, Germany, the Netherlands, Great Britain, France, China, Canada and the USA. Handicare's products are also distributed by partners in more than 40 countries worldwide. Our wide range of high-quality products includes various manual and power wheelchairs, seating systems, scooters, a complete easy transfer system and other patient handling aids, stairlifts, car adaptations, rise and recline chairs, and bathing and toileting products.



handicare

Handicare AB
Maskinvägen 17
SE-972 54 Luleå, SWEDEN
Tel: +46 (0)8-557 62 200
Fax: +46 (0)8-557 62 299
E-mail: info@handicare.se
www.handicare.com