



SWL: 170 kg/375 lbs



Functional inspection

Visual inspection

Check the condition and function of the assistive device regularly. Check to ensure that seams and material are free from damage. If there are signs of wear, the product must be inspected and serviced.



Always read the manual

Always read the manuals for all assistive devices used during a transfer.

Keep the manual where it is accessible to users of the product.

Do not leave the patient unattended during a transfer situation.

The product should be inspected yearly, and otherwise as required, by a qualified technician.

Service must be performed by a qualified technician.

Table of contents

Description of parts	3
Functions	3
General	3
Exploded view	4
Component list	5
Spare parts	6-8
Spare part list	6
Replacing spare parts	7
Periodic inspection	9-11
Detail descriptions for Periodic inspection	9
Periodic inspection, instruction	10-11
Care of the product	12
Technical information	13

Description of parts



1. Seat support
2. Depth adjustable kneepad
3. Angle adjustment of the seat
4. Manual adjustment of seat depth
5. Height adjustable knee pad
6. Footpedal for leg spread adjustment
7. 2 x rear braked castors
8. Detachable footplate

Functions

Split seat pads: both swing away and flip-up.

Knee pad: depth and height adjustable and tiltable.

Foot pedal: for adjusting leg spread in and out.

Angle adjustment crossbar: adjusts seat and handgrip angle up or down to optimise seating comfort and positioning of user.

Seat depth: two positions, manually adjustable.

Footplate: covered with non-slip surface, detachable.

General

Before the product is used, check to ensure that the screws are securely tightened. The product must be inspected regularly by an authorized technician. The product must be inspected thoroughly at least once each year, or more regularly if it is used very frequently. Inspection and service must be performed by an authorized technician.

Exploded view

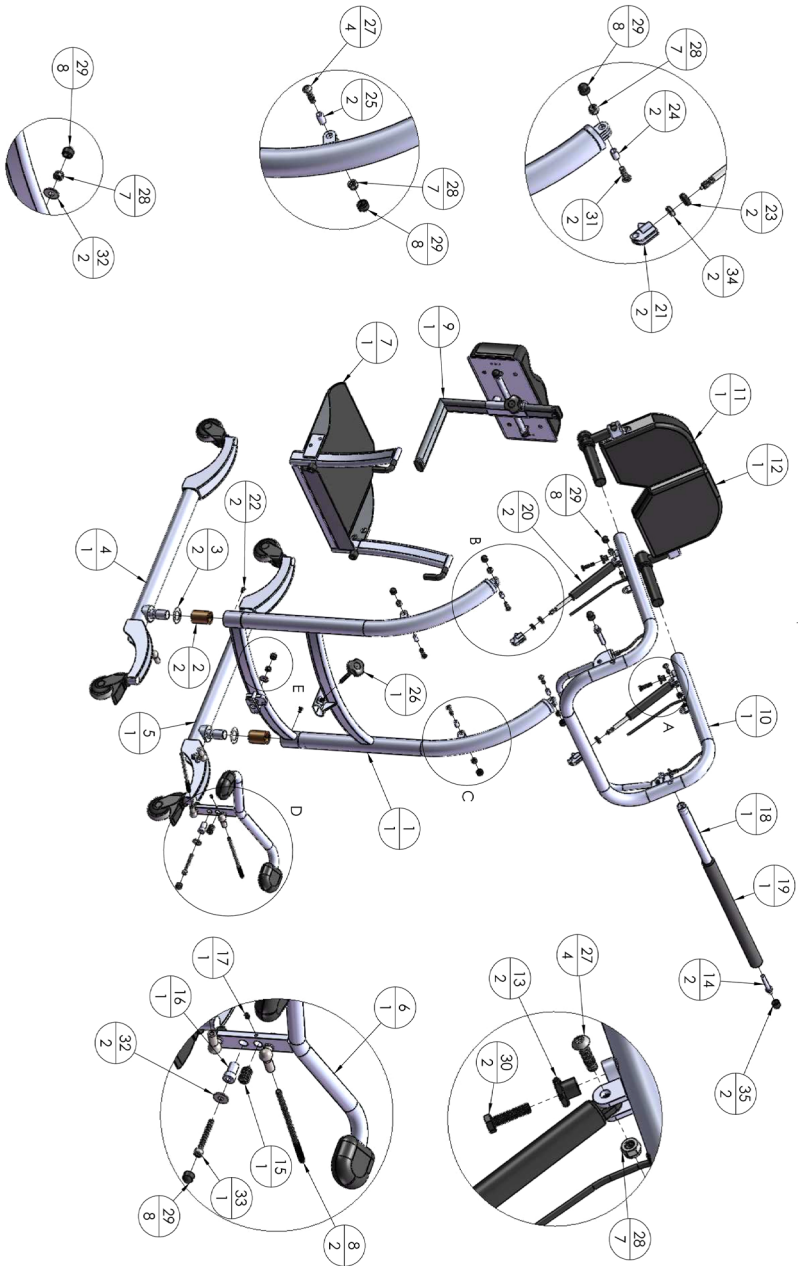







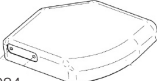

Component list

Number	Name	Size
1	Frame	
2	Bronze plain bearing	
3	Disc	
4	Left leg mounted	
5	Right leg mounted	
6	Legspread mounted	
7	Footplate mounted	
8	Threaded pin	M8 DIN 975
9	Knee pad holder	
10	Top hanger	
11	Right seat assembly	
12	Left seat assembly	
13	Off-center adjuster	
14	Belt bolt	
15	Screw with spring and ball	
16	Clamping bolt	
17	Screw	M6x10/8.8 - DIN 914
18	Grip pipe/welded	
19	Foam grip	
20	Gas spring	
21	Release head/gas spring	
22	Screw	M6x12/8.8 - ISO 7380
23	Plastic spacer	20x 10.5/10 mm
24	Spacer	10x1/16 mm
25	Spacer	10x1/20 mm
26	Handwheel/60 mm threaded rod	
27	Screw	M8x30/8.8 - ISO 7380
28	Self locking nut	M8/8.8 - DIN 985
29	Plastic nut cover	M8
30	Screw	M8x30/8.8 - DIN 933
31	Screw	M8x25/8.8 - ISO 7380
32	Washer	M8 - DIN 9021
33	Screw	M8x60/8.8 - DIN 912
34	Nut	M10x1/8.8 - DIN 439
35	Plastic nut cover	M10 (long)

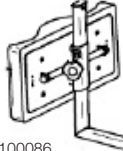
Spare parts

Spare part list

Artikelnummer	Produkt	Enhet	Komponenter	Bilder
80100084	Seat kit left QM	1 set	1 x Seat left 2 x Screw M8x20	 80100084
80100085	Seat kit right QM	1 set	1 x Seat right 2 x Screw M8x20	 80100085
80100049	Front castor kit 80mm	1 set	1 x Castor without brake 1 x Locking nut	 80100049
80100073	Rear castor kit 80mm	1 pce	1 x Castor with brake	 80100073
80100086	Knee pad complete QM	1 pce	1 x Knee pad holder	 80100086
80100087	Footplate complete QM	1 pce	1 x footplate holder	 80100087
80100088	Gas spring	1 set	2 x Gas spring 4 x Locking nut	 80100088
80100089	Cable set for gas spring	1 set	2 x Cable 4 x Rubberwasher 2 x Adjustment screw M7	 80100089
80100077	Locking handle knee pad	1 set	2 x Handle 50mm	 80100077
80200016	Belt nut covers	1 set	10 x Nut cover	

Change of spareparts

Seat support

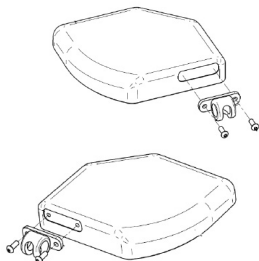

Disassemble and change the seat support by unlocking the two screws according to picture. Use the attached screws to assemble the new seat support and please note that there is a left and right seat support.

Front castors



Disassemble and change the front castors by unlocking the underneath mounted screw according to picture. Use the attached screw to assemble the new castor and ensure correct tightening.

Rear castors with brakes



Disassemble and change the rear castors by unlocking the underneath mounted screw according to picture. Use the attached screw to assemble the new castor and ensure correct tightening.

Knee pad



First, loosen the outermost screw, on the underside of the rail to which the knee pad is attached, on the part that allows inward and outward adjustment of the knee pad. Then, loosen the locking knob. Install the new knee pad, secure it with the locking knob, and then tighten the small screw on the underside of the rail.

Footplate



Remove the footplate. No tools are required. Install the new footplate.

Gas spring cable set for gas spring



Disassemble and change the gas springs by unlocking the nuts according to picture.



Disconnect the cable set by first loosen the adjustment screw on the cable and secondly unhook the cable from the bracket. Attach the new cable set to the old one, while still mounted in the frame, and change the old cable by pulling the cable through the frame. Ensure correct mounting and adjustment by function control.



Periodic inspection

Detail descriptions for Periodic inspection

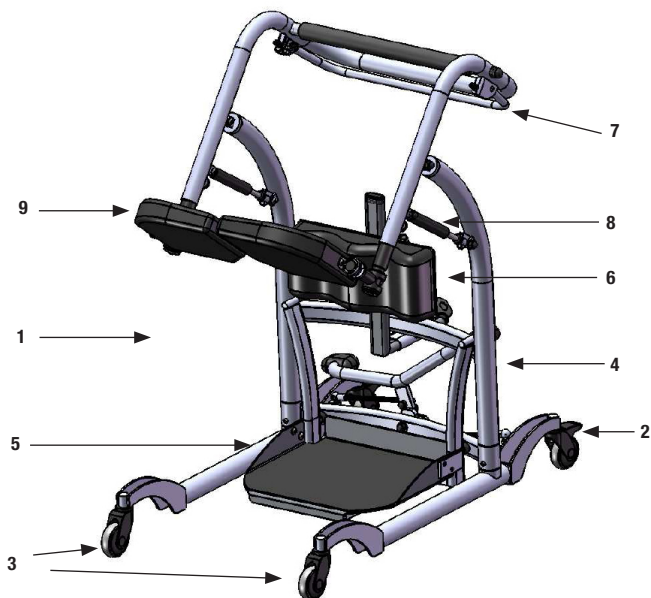

1. Frame and pivote points	Page 7
2. Brakes	Page 7
3. Castors	Page 7
4. Footpedal for leg spread adjustment	Page 7
5. Detachable footplate	Page 7
6. Leg support	Page 8
7. Angele adjustment crossbar	Page 8
8. Gas spring	Page 8
9. Seat support	Page 8

Periodic inspection, instruction

Frame and pivote points



Check screws, nuts and bolts.

Check the frame for visible damage to the surfaces, finish, etc.

Brakes



Lock the brakes. Check that the castors do not turn when the QuickMove is pushed.

Castors



Roll the QuickMove unloaded on the floor, check that the castors roll and turn freely. Check that the castor fasteners are tight and if necessary, remove dirt and hair from wheels.

Footpedal for leg spread adjustment



Check the footpedal for adjusting the leg spread in and out.

Detachable footplate



Check the footplate for visible damage to the surfaces, finish, etc. Make sure it is correctly assembled.

Make sure that the covered with non-slip surface is ok.

Knee pad



Check the knee pad for visible damage to the surfaces, finish, etc. Make sure it is correctly assembled.

Check the adjustment for knee pad, depth, height and tiltable.

Angle adjustment crossbar



Check that the angle adjustment crossbar is activating the gas springs.

Gas spring



Check that the gas springs are moving smooth and soft.

Seat support



Check the seat supports for visible damage to the surfaces, finish, etc.

Check the split seat pads: both swing away and flip-up.



Care of the product:

- Use a soft cloth and mild cleaning agent such as dishwashing liquid or car shampoo to clean the QuickMove. Do not use abrasive cloths or brushes.
- Do not use solvents.
- To disinfect, use 70% alcohol.

Technical information

A Length	900-1030 mm	35.4 – 40.5"
B Width, inner. Min. leg spread. Castor to castor.	455 mm	17.9"
C Width, inner. Max. leg spread. Castor to castor.	830 mm	32.6"
D Width, outer. Min. leg spread. Castor to castor.	615 mm	24.2"
E Width, outer. Max. leg spread. Castor to castor.	1050 mm	41.3"
F Width between legs. Min. leg spread.	480 mm	18.8"
G Width between legs. Max. leg spread.	620 mm	24.4"
H Height adjustment: Floor to pushbar	1065 – 1120 mm	41.9 – 44"
I Height: Floor top of castor frame	145 mm	5.7"
J Height: Floor top of leg	45 mm	1.7"
K Seat height: Min.	730 mm	28.7"
L Seat height: Max.	850 mm	33.4"
Seat width: 480 mm 18.8"		
Seat depth: 265 mm 10.4"		
Castor Ø 80 mm 3.1"		
Weight: 35 kg 77 lbs		
Max. weight capacity: 170 kg 375 lbs		

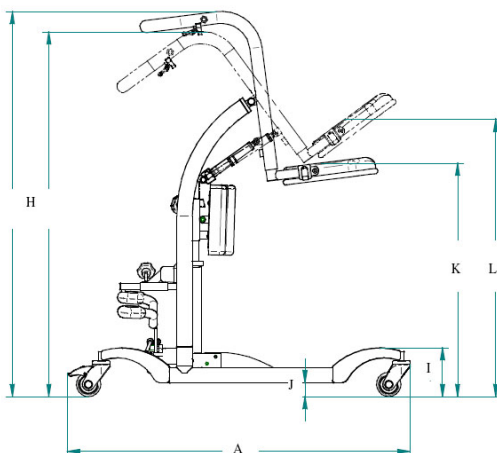
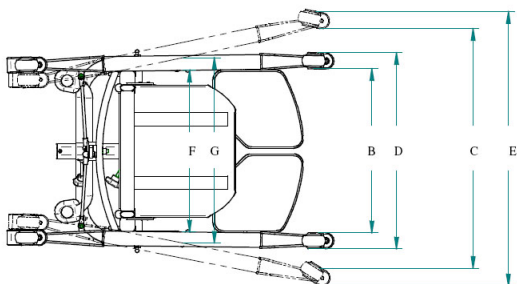

Simple solutions for great results

SystemRoMedic® is the name of Direct Healthcare Group's unique easy transfer concept, the market's widest and most comprehensive range of clever, easy-to-use and safe transfer and lifting aids designed to make life easier, both for the user and for the caregiver. SystemRoMedic® is a complete solution that provides for the majority of patient transfer or manual handling requirements. From the simplest to the most complex scenarios, from the lightest to the heaviest. The concept encompasses assistive devices for four different categories of transfers:

- Transfer, assistive devices for manual transfers of users between two locations.
- Positioning, assistive devices for manual repositioning of users within the same location.
- Support, assistive devices for mobility support e.g., during sit-to-stand or gait training.
- Lifting, assistive devices for manual and mechanical lifting of users.

Improved work environment, improved quality of care and cost savings

The philosophy behind SystemRoMedic® is focused on the prevention and reduction of occupational injuries while allowing users to experience a greater sense of independence and dignity. Through a unique combination of training and a complete range of efficient transfer aids, SystemRoMedic® offers improvement of both work environment and quality of care and, at the same time, achieves significant cost savings.

Always make sure that you have the correct version of the manual

The most recent version of all manuals are available for downloading at/from our website;
www.directhealthcaregroup.com

For questions about the product and its use

Please contact your local Direct Healthcare Group and SystemRoMedic® representative. A complete list of all our partners with their contact details can be found on our website; www.directhealthcaregroup.com.



Moving Health Forward

Direct Healthcare Group Sverige AB
Torshamnsgatan 35,
SE-164 40 Kista, Sweden

Tel: +46 (0)8-557 62 200
info@directhealthcaregroup.com
www.directhealthcaregroup.com



Medical Device Class I. The product complies with the requirements of the Medical Devices Regulation 2017/745.