



Linido
Bathroom Safety
Catalogue

**Direct Healthcare
Group**
Advancing Movement & Health®

80 years of experience

With safety paramount and with attention to ergonomics, usability and durability, we have been designing and producing quality products that meet the needs of the professional market for 80 years.

1938

Linido

Founding of Linido

1st of January 1938, Linido commercial company was founded in Delft by Mr Joseph Koet. Brother Karel Koet, who was an MS patient himself, had devised a system to prevent pressure sores (decubitus) for himself. He designed a mattress of interwoven rubber that offered him many benefits. He also got an international patent on it.

1949



Decubitus mattress

Specially designed to prevent decubitus. The name Linido also arose from this invention: **L**igt **N**iet **D**oor, which means "Does not cause pressure sores". These were steel frames with rubber strips stretched around them. The beds were lightweight and compact. Several submarines and officers' cabins were even equipped with these beds. A real innovation!

1962



The Village

'Open The Village' was a Dutch television programme from AVRO. It was the first major fund-raising programme on Dutch television. The intention of Open the Village was to collect money for a residential community and care facility for the disabled, and it was presented by Mies Bouwman, who was a well-known tv personality. Linido was highly involved in the construction and provided the first generation of shower chairs there.

1971



Ergo shower seat

A further improvement in comfort and quality by equipping the shower seat with moulded plastic mats. With the major advantages that this simplified cleaning and increased durability.

2017

The Compact shower seat is designed with attention to every detail and offers comfort in the modern bathroom. With its small size, this shower seat can really be installed anywhere.

Ideal for a smaller bathroom, where this seat can be used to full advantage. Folded down, it is a stylish feature in the shower and requires little room, as it is only 4cm thick.



1982



Introduction of hinged arm support

The hinged arm support as it is today came about in collaboration with a boarding school for people with a physical disability. A unique feature of the hinged arm support is that it can be vertically locked.

2003



New Ergo shower seat

The most recently introduced ergonomic model, which has been developed with attention to design in addition to safety, usability, ergonomics and durability. Made entirely of durable plastic with concealed mounting. Today our shower seat also features a hygiene coating that simplifies maintenance even more and therefore reduces the presence of bacteria significantly.

2016



Introduction of Anthracite

The anthracite product line offers a fully coated version with a uniform anthracite colour of steel and a version in polished stainless steel with anthracite details for a more stylish look. The anthracite colour is not only beautiful, it also offers contrast on a light-coloured wall, making supports more visible in the event of a visual impairment.

2020

Direct Healthcare Group

Advancing Movement & Health[®]

Joining the Direct Healthcare Group

In 2008, Linido was acquired by the Direct Healthcare Group. Direct Healthcare Group is a truly international company with production and sales organisations in the United Kingdom, Norway, Sweden, Denmark, the Netherlands, Belgium and France. In addition, our products are sold through distributors in over 40 countries.



Ergonomic design

Linido bathroom aids by Direct Healthcare Group have been renowned more than 80 years, both in the home as in healthcare facilities. The complete range provides users in any bathroom or toilet situation with as much autonomy as possible.

Direct Healthcare Group offers solutions that increase the independence of people with disabilities and at the same time simplify the care to be given by family, caregivers and therapists.

TABLE OF CONTENTS BATHROOM AIDS

SHOWER SEATS	7
GRAB RAILS	15
TOILET AIDS	23
WASHBASIN AIDS	31
BATH AIDS & SHOWER STRETCHERS	35
SHOWER/TOILET CHAIRS & STOOLS	39
Commode/shower chairs	40
Shower chairs	44
Shower stools	46
Shower trolleys	48
Swimming pool products	49
Combi shower and toilet chairs	50
USEFUL INFORMATION	
Direct Healthcare Group Academy	14
Maintenance instructions	38
Technical information	52
Mounting advice	53
Ergonomic mounting advice	54



Safe

Our products conform to the highest standards and are suitable for users with a body weight of up to 150kg. We are ISO 9001, ISO 13485 and NKH certified.



Practical

The design of our products is the result of extensive research and offers solutions for every disability. They are comfortable, safe, and easy to clean.



Durable

Adaptations to changing needs are possible, all materials used are resistant to moisture, heat and cold in the bathroom.



Ergonomics

Our products take into account the possibilities and limitations of users. They promote independent function and reduce the risk of falling.



Design

The round shapes are hygienic, and ensure you do not get caught. Mounting points are obscured. Available in standard and luxury versions.

GENERAL

Linido bathroom solutions by Direct Healthcare Group are exclusively available through professional retailers. For information please call **Customer Service: +44 (0) 800 043 0881** or mail to: **info@directhealthcaregroup.com**

Guaranteed quality

Linido bathroom solutions conform to the highest standards and comply to the requirements of NEN-EN12182 and to the directive medical devices 93/42/EEG. We are ISO 9001, ISO 13485 and NKH certified (NKH = National Quality Mark for bathroom aids).



Colours

Linido bathroom solutions for wall mounting are supplied standard in white, RAL 9010. Many products are also available in polished stainless steel. Direct Healthcare Group introduces a range in the new colour anthracite, RAL 7021. This colour matches the newest trends in modern luxury bathrooms. The new colour anthracite replaces the colour black. The colours black, crème-white, red and blue are no longer available.



Materials

The products are made of:

- coated steel
- glass fibre reinforced nylon
- coated stainless steel 304 (recommended for use in institutions)
- polished stainless steel 304 (recommended for use in institutions)
- polished stainless steel 316 (recommended for use in swimming pools)
- HT-cover = Hygiene & Transfer: coated woven polyester textile

Because of the necessary electrical isolation, products for wall mounting or floor mounting, which are not designed with plastic flanges or wall plates, will be delivered with an isolation set including heavy duty washers and caps.

New Compact shower seat

On page 8, you can read more about our new Compact shower seat. This shower seat for wall mounting is especially designed for the home environment, with attention to details, and offers comfort in the modern bathroom. In addition to the modern design, the seat can safely support a user weight up to 150kg.

New aluminium shower stools

Our range of mobile bathroom products has been expanded with two new lightweight shower stools. The shower stools have an aluminium powder-coated frame and are equipped with a removable soft polyurethane seat. The stools are adjustable in height and can be optionally equipped with a backrest; read more about it on page 47.

New seat for height-adjustable, tilting shower/toilet chair

The well-known toilet seats of our standard shower/toilet chairs are now also provided on our height-adjustable chairs (LI2161-series). The chairs have a hygienic hinged toilet seat as standard equipment. In addition, it is also possible to order the chair factory-delivered with a neoprene toilet seat. You can order neoprene on our shower/toilet chairs under option number 106. See page 43.

BIM & building specification service

Alongside 2D-CAD drawings, Direct Healthcare Group also offers 3D-models to support the BIM-process. BIM (Building Information Model) can be used in several software packages (as can REVIT), so professionals can work with it. In our Architect's Service we offer also the texts for the building specification documents.

Fixing materials

Linido products will be delivered without any fixings, except for bathroom accessories. What constitutes a secure installation depends on the type of wall. Working with a wall of plasterboard, pressed fibreboard or chip board, it is necessary to reinforce the wall with for instance waterproof plywood. The type of wall will also determine the type of wall plugs or screws to be used. Please read page 34 for all mounting advice, which is also available on our website.

Direct Healthcare Group has taken the utmost care in compiling this catalogue. All prices mentioned are in euro's, exclusive VAT. Composition of the range and prices in this catalogue can alter at a later date. Direct Healthcare Group accepts no responsibility whatsoever for any damage arising from the use of this information. Direct Healthcare Group is not liable for modified products.

Direct Healthcare Group

Advancing Movement & Health®



Shower seats



New: Direct Healthcare Group Compact shower seat

Comfortable seated showering on a shower seat with Scandinavian design. This shower seat for wall mounting is especially designed for the home environment, with attention to details, and offers comfort in the modern bathroom. The seat is antibacterial and wear-resistant. The maximum user weight for the shower seat is 150kg.

Shower seats

Compact shower seat

- antibacterial Corian seat, hinged, wall-plate anodized aluminium
- seat width 265mm
- seat depth 326mm
- suitable for user weight up to 150kg
- including drilling template
- only available in the EU

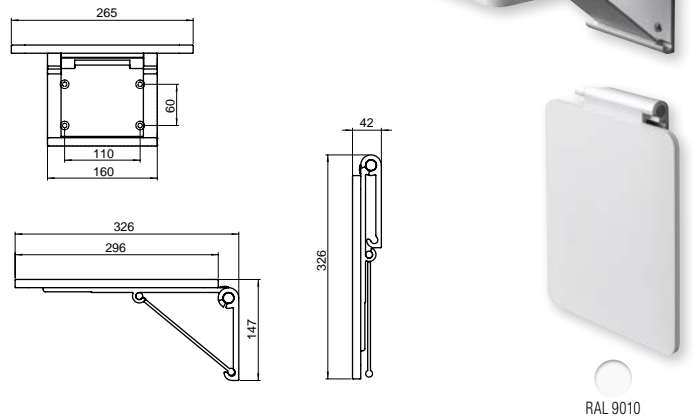

Article nr.	Description
LI2201.2013-02	Compact shower seat, white

Ergonomic shower seat

- plastic seat, hinged
- seat width 450mm
- seat depth 405mm
- suitable for user weight up to 150kg
- including drilling template
- wall fixing set available (LI2806.000)
- provided with hygiene coating

△ Floor support set LI 2214.201 recommended with a body weight > 100kg dependant on the wall structure.

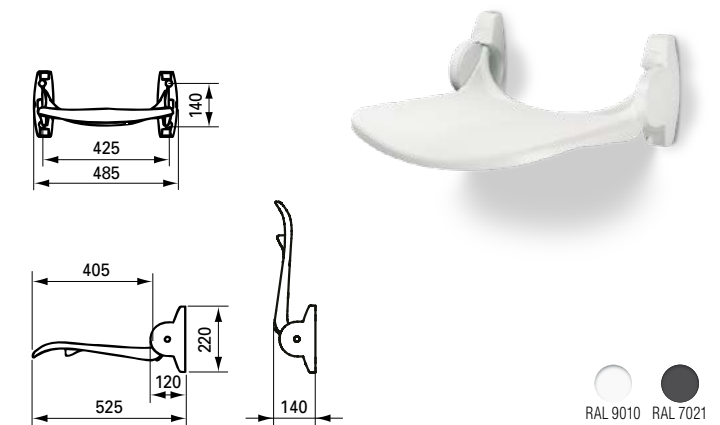

Article nr.	Description
LI2201.2006-02	Ergonomic shower seat white
LI2201.2006-11	Ergonomic shower seat anthracite
LI2806.0000-00	Wall mounting set for LI2201 LI2601/03.

Ergonomic shower seat with backrest

- plastic seat, hinged
- plastic back, reinforced by stainless steel tube
- seat width 450mm
- seat depth 405mm
- suitable for user weight up to 150kg
- including drilling template
- wall fixing set available (LI2805.000)
- provided with hygiene coating

△ Floor support set LI 2214.201 recommended with a body weight > 100kg dependant on the wall structure.

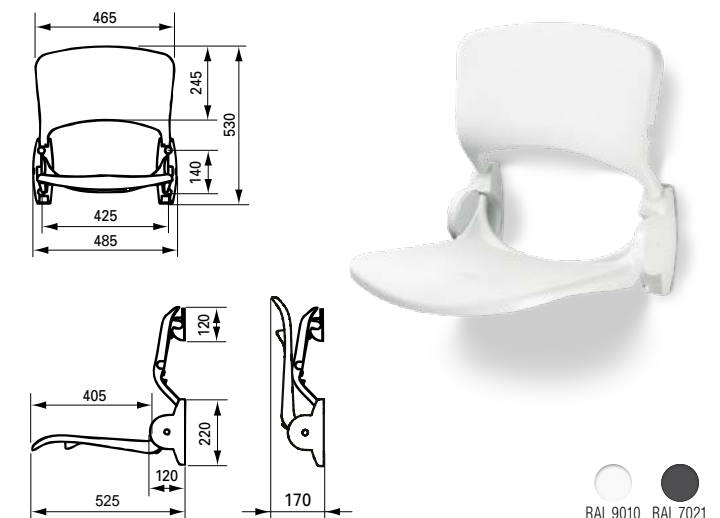

Article nr.	Description
LI2202.2006-02	Ergonomic shower seat with backrest, white
LI2202.2006-11	Ergonomic shower seat with backrest, anthracite
LI2805.0000-00	Wall mounting set LI2202 & LI2203

Installing securely: What constitutes a secure installation depends on the type of wall, in combination with the correct fixing materials. Working with a wall of plasterboard, pressed fibreboard or chip board, it is necessary to reinforce the wall with for instance waterproof plywood, min. 32mm thick. Please read page 34 for all mounting advice or look on directhealthcare.com.
 Wall fixing set for walls with sufficient strength are separately available. Information about these sets is supplied with the articles.

Shower seats

Ergonomic shower seat with backrest and armrests

- plastic seat, hinged
- plastic back, reinforced by stainless steel tube
- independent swivel armrests, ergonomic shape
- seat width 450mm, seat depth 405mm
- suitable for user weight up to 150kg
- including drilling template
- wall fixing set available (LI2805.000)
- provided with hygiene coating

△ Floor support set LI 2214.201 recommended with a body weight > 100kg dependant on the wall structure.

△ With a body weight >125kg we advise to use a shower seat without armrests (LI2202.200) in combination with hinged arm supports (LI2603.3xx) at both sides.

Please see page 52 for information about weight limits.

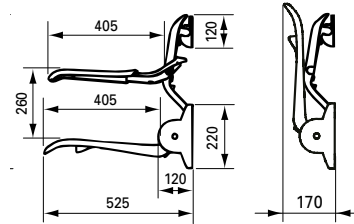
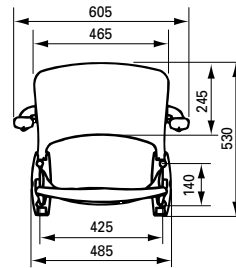

○ RAL 9010 ● RAL 7021

Article nr.	Description
LI2203.2006-02	Ergonomic shower seat with backrest and armrests, white
LI2203.2006-11	Ergonomic shower seat with backrest and armrests, anthracite
LI2805.0000-00	Wall mounting set LI2202 & LI2203

Floor support set for ergonomic shower seats

- fits Linido ergonomic shower seats LI2201.200, LI2202.200, LI2203.200
- hinges with the seat
- consists of double leg support and double distance arm
- continuous height adjustment to accommodate seat height (from floor to top of seat: 420–570mm)
- can also be fitted after installation
- maximum load 300kg

△ Recommended with a body weight > 100kg dependant on the wall structure.

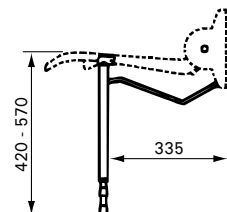
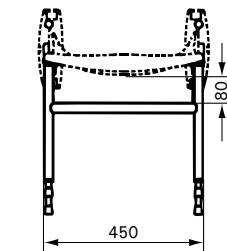

○ RAL 9010 ● RAL 7021

Article nr.	Description
LI2214.2011-02	Floor support set for ergonomic shower seat LI220x white
LI2214.2011-11	Floor support set for ergonomic shower seat LI220x anthracite
LI2214.2014-02	Floor support set for ergonomic shower seat LI220x ss/white

Short shower seat

Only available in these measurements.

LI2203.001

- seat HT-cover* material, hinged
- backrest HT-cover* material
- independent swivel armrests
- seat width 450mm
- seat depth 315mm (distance from wall to front side seat 445mm)

LI2201.001 (not shown)

- as LI2203.001, without backrest and armrests (distance from wall to front side seat 375mm)

△ Floor support set LI 2214.002 recommended with a body weight > 100kg depending on wall structure.

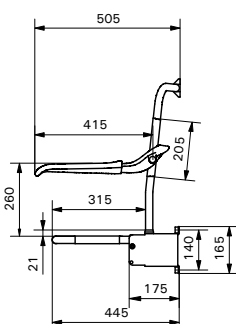
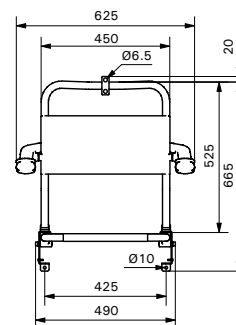

○ RAL 9010

Article nr.	Description
LI2201.0011-02	Short shower seat white
LI2201.0014-02	Short shower seat ss/white
Wall mounting kit	
LI2805.0000-00	Wall mounting kit LI2202 & LI2203
LI2214.0021-02	Floor support set for short shower seat white
LI2214.0024-02	Floor support set for short shower seat ss/white

Shower seats

Soft shower seat

LI2223.021

- hinged soft toilet seat with open front
- backrest HT-cover* material
- independent swivel armrests, ergonomic shape
- rails for bedpan Ø 300–315mm (p.42)

LI2221.021 (not shown)

- as LI2223.021, without backrest and armrests (distance from wall to front side seat 500mm)

△ Floor support set LI 2214.001 recommended with a body weight > 100kg depending on wall structure.

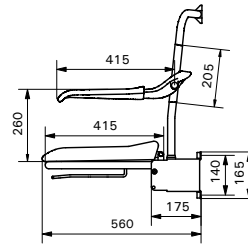
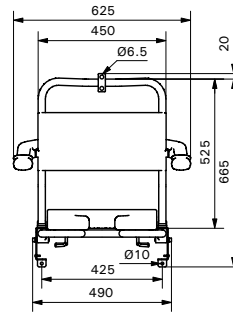

○ RAL 9010

Article nr.	Description
LI2221.0211-02	Soft shower seat, open front, white
LI2221.0214-02	Soft shower seat, open front, ss/white
LI2223.0211-02	Soft shower seat, open front, white
LI2223.0214-02	Soft shower seat, open front, ss/white
LI2214.0011-02	Floor support set for shower seat LI222x white
LI2214.0014-02	Floor support set for shower seat LI222x ss/white
Wall mounting kit	
LI2805.0000-00	Wall mounting kit LI2202 & LI2203

Click-On frame for ergonomic shower seat

△ can only be attached to the following Ergogrip grab rails: LI2611.060, LI2611.070, LI2611.080, LI2611.160, and to: horizontal angled grab rail LI2611.015; angled grab rail for two walls LI2611.016

- with safety lock to secure to the grab rail
- suitable for shower seat LI2202.200 and LI2203.200
- distance from grab rail to top side of seat: 475mm
- frame of stainless steel tube
- easily mounted and removed on holding rails without tools
- **NOTE:** Direct Healthcare Group advises the use of the floor support set LI2214.201 when using a click-on frame

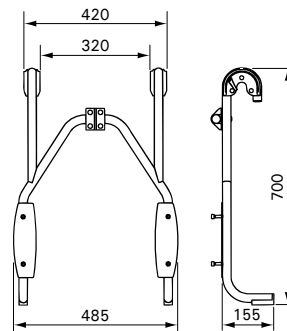

○ RAL 9010 ● RAL 7021

Article nr.	Description
LI2216.0014-02	Click-On frame for ergonomic shower seat, white
LI2216.0014-11	Click-On frame for ergonomic shower seat, anthracite

Click-On frame for ergonomic shower seat, height adjustable

- as LI2216.001, but with variable sitting height
- adjusting range 100mm
- space between grab rail and upper side seat: 400–500mm
- **NOTE:** Direct Healthcare Group advises the use of the floor support set LI2214.201 when using a click-on frame

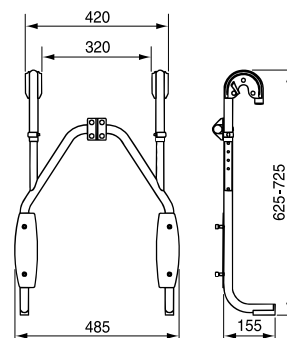

○ RAL 9010 ● RAL 7021

Article nr.	Description
LI2216.0024-02	Click-On frame for ergonomic shower seat, adjustable, white
LI2216.0024-11	Click-On frame for ergonomic shower seat, adjustable, anthracite

Shower seats

Cushioned cover for ergonomic shower seat

- soft removable cushion, suitable for shower seats LI2201.200, LI2202.200, LI2203.200
- a softer cushion for a sensitive skin or longer use of the shower seat
- easy to fix and change by means of velcro at the bottom of the seat
- Poly-ethylene/poly-propylene foam
- only in blue
- guarantee 1 year

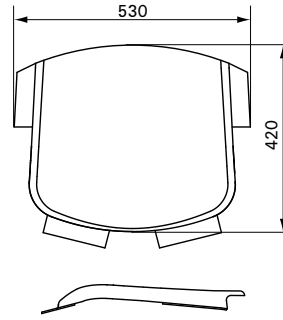

Article nr.	Description
LI09506.400	Cushioned cover for ergonomic shower seat

Height adjustment system

- can be used for shower seat without backrest LI2201.200, LI2201.001 & LI2221.021
- smooth adjustment to required seat height
- also allows mounting of shower seat at a later stage
- height adjustment 150mm
- including drilling template
- set adjustable clamp levers available (LI2815.001)

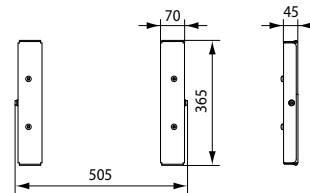

Article nr.	Description
LI2215.1014-02	Height adjustment system for seat without backrest, ss/white



RAL 9010

Height adjustment system

- can be used for shower seats with backrest LI2202.200, LI2203.200, LI2203.001 & LI2223.021
- smooth adjustment to required seat height
- also allows mounting of shower seat at a later stage
- height adjustment 150mm
- including drilling template
- set adjustable clamp levers available (LI2815.002)

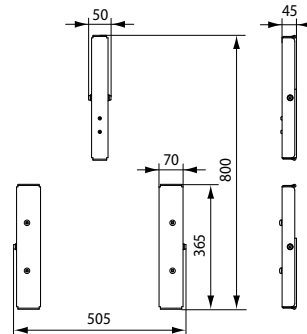

Article nr.	Description
LI2215.1024-02	Height adjustment system for seat with backrest, ss/white



RAL 9010

Set adjustable clamp levers

LI2815.001

- For height adjustment system LI2215.001
2 items, black plastic

LI2815.002

- For height adjustment system LI2215.002
4 items, black plastic



Article nr.	Description
LI2815.0010-00	Set 2 adjustable clamp levers for use with LI2215.101
LI2815.0020-00	Set 4 adjustable clamp levers for use with LI2215.102

Shower seats

Set backing plates

- for fixing Linido shower seat from rear of wall
- comes with nuts M8 welded on the plate and threaded studs, washers and nuts
- supplied with backing plate for shower seats with backrests
- backing plate visible at back side of the wall
- only in white

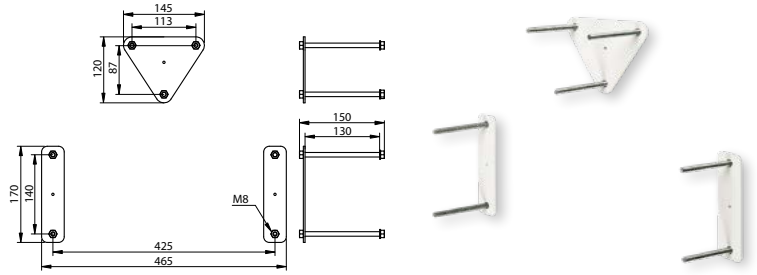

Article nr.	Description
LI0122.5084-02	Set backing plates for shower seats, ss/white

Mounting set for shower seats LI2201.200/LI2202.200/LI2203.200

- replacement set
- for covering the fixing holes and installing the backrest to a wall
- backrest hook clamp is white

NOTE: this set is supplied as standard with our shower seats LI2202.200/ LI2203.200

Article nr.	Description
LI2801.0000-02	Mounting set for shower seats 2201 white
LI2801.0000-11	Mounting set for shower seats 2201 anthracite
LI2803.0000-02	Mounting set for shower seats 2202/2203 white
LI2803.0000-11	Mounting set for shower seats 2202/2003 anthracite

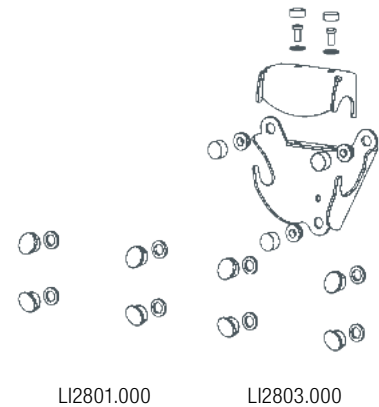

Wall mounting kits for shower seats

LI2806.000 for mounting Linido shower seat LI2201.200

- consisting of: – Fischer UX 10 plugs, 4 pieces;
 – lag screw, 8 x 90mm SS A2, 4 pieces;
 – washer M8 DIN 125, stainless A2, 4 pieces.

LI2806.000-00



LI2805.000 for mounting Linido shower seats LI2202.200 en LI2203.200 consisting of:

- Fischer UX 10 plugs, 7 pieces;
 – lag screw, 4 pieces 8 x 90mm stainless A2 en 3 pieces 8 x 70mm stainless A2
 – washer M8 DIN 125, stainless A2, 7 pieces.

LI2805.000-00



Article nr.	Description
LI2806.0000-00	Wall mounting kit LI2201 & LI2601/03.
LI2805.0000-00	Wall mounting kit LI2202 & LI2203

Floor support installation set

- replacement set
- for mounting a floor support
- standard available in white

NOTE: this set is supplied as standard with floor support LI2214.201

Article nr.	Description
LI2804.0000-02	Installation set for floor support LI2214.201, white

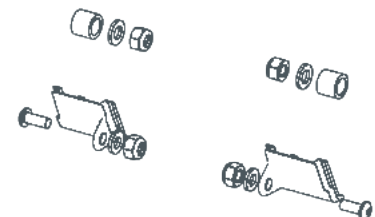

Shower seats

Shower seat with floor support

- hinged shower seat with open front, folding
- aluminum frame, coated stainless
- seat: plastic
- seat width 410mm
- seat depth 365mm
- height adjustable between 400–500mm
- suitable for user weight up to 150kg
- 2 year guarantee
- not available in the USA



Article nr.	Description
12226	Shower seat (U-shape) with floor support



ethos

EDUCATION PROGRAMME



Direct Healthcare Group – more than just products

In order for assistive technology to be used to its full potential, those using our products must have both an understanding of everything a piece of equipment can accomplish and the skills to use it in the best possible way in every single situation.

At Direct Healthcare Group, we want our customers; healthcare providers, healthcare professionals, family members and users to get optimum use and value from our assistive devices and solutions. Therefore, we do not stop at the innovation, design and manufacturing process but we also take great care to develop means and methods for sharing our knowledge and experience gained from creating safe and easy solutions for all users in all transfer situations.

New skills. New choices. Better outcomes.

With Ethos, our objective is to deliver superior knowledge and first-hand experience of basic core principles and techniques to demonstrate how our assistive devices can be most effectively used to provide safe and easy-to-use transfer solutions that result in:

- **Improved work environment**
prevention and reduction of occupational injuries for the caregivers
- **Improved quality of care**
enabling users to use as much of their ability as possible for rehabilitation and greater independence and dignity
- **Significant cost-savings for the care providers**



Our tutors and trainers

Our tutors training sessions are delivered by individuals who have extensive practical experience and theoretical knowledge of the topics that they cover. Depending on the content covered tutors are either specialist members of the Direct Healthcare Group team or independent industry experts.

How can I book a workshop?

Once you have chosen your workshop, please email ethos@directhealthcaregroup.com advising of your chosen workshop and 2–3 preferred dates when you intend to run the workshop. Minimum delegates required for each workshop to run is 6, maximum 12. We are pleased to offer the Ethos Education Programme free of charge for healthcare professionals, we kindly ask that as the organiser, you arrange a suitable venue with access to a profiling bed. Please note, Direct Healthcare Group reserve the right to change in certain situations at a rate of £90 per delegate, per workshop. For more information, please visit www.directhealthcaregroup.com

Tailor-made training and consultations from experienced professionals

Our Ethos team has a wealth of experience and this allows them to create training packages that are tailored to your requirements which means we can offer you training that fits around your team's logistical and time constraints.

For more information about how our personalised training service can help your team, please contact ethos@directhealthcaregroup.com

Grab rails



Real support in your bathroom

Our grab rails have been renowned for more than 80 years. This practical support can be mounted everywhere: in the shower, next to the washbasin or next to the toilet. As a result of the ergonomic diameter of the tube, both a big and a small hand will have a safe grip. The 60° angle, instead of 90°, ensures that the hand of the user remains in a natural position. This ensures a pain-free grip and reduces the risk of falling.

Grab rails

Ergogrip

Ergogrip grab rails are suitable for users with a body weight of up to 150kg. They are made of steel or stainless steel tube and have a plastic flange with a plastic cover. As the tube is bent to 60° instead of the traditional 90°, hand and wrist retain a natural position while holding the Ergogrip. In combination with the flange the Ergogrip has a smooth form which offers a firm grip.



Thanks to the proper combination of shape and diameter of the tube, the user of the grab rail can achieve an optimal grip. Based on scientific data, Direct Healthcare Group has designed a grab rail that meets the requirements set by users of the product in terms of shape, tube diameter, bending angle and wall distance.

Ergogrip 200 grab rails

Length = A B C
LI2611.020 180 200 275

- mounting set available (LI2807.000, see page 16)
- combine with backing plate LI0126.503 (page 16) when in doubt about strength of wall

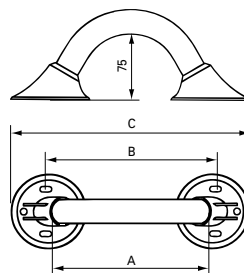

length A is the grip size



Article nr.	Description
LI2611.0201-02	Grab rail 20cm white
LI2611.0201-11	Grab rail 20cm anthracite
LI2611.0204-02	Grab rail 20cm ss/white
LI2611.0202-00	Grab rail 20cm polished ss, details white
LI2611.0202-11	Grab rail 20cm polished ss, details anthracite



Grab rails

Ergogrip straight grab rails

	Length =	A	B	C
LI2611.030		300	317	405
LI2611.040		400	417	505
LI2611.050		500	517	605
LI2611.060		600	617	705
LI2611.070		700	717	805
LI2611.080		800	817	905
LI2611.090		900	917	1005
LI2611.100		1000	1017	1105
LI2611.120		1200	1217	1305
LI2611.140		1400	1417	1505

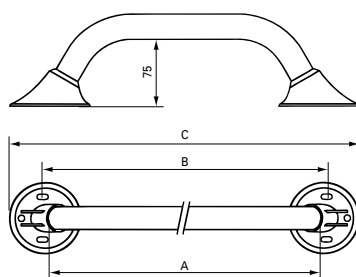

length A is the grip size



- mounting set available (LI2807.000), see page 20
- combine with backing plate LI0126.503 (page 20) when in doubt about strength of wall

Article nr.	Ergogrip 300, length 30cm
LI2611.0301-02	Ergogrip grab rail 30cm white
LI2611.0301-11	Ergogrip grab rail 30cm anthracite
LI2611.0304-02	Ergogrip grab rail 30cm ss/white
LI2611.0302-00	Ergogrip grab rail 30cm polished ss, details white
LI2611.0302-11	Ergogrip grab rail 30cm polished ss, details anthracite
Article nr.	Ergogrip 400, length 40cm
LI2611.0401-02	Ergogrip grab rail 40cm white
LI2611.0401-11	Ergogrip grab rail 40cm anthracite
LI2611.0404-02	Ergogrip grab rail 40cm ss/white
LI2611.0402-00	Ergogrip grab rail 40cm polished ss, details white
LI2611.0402-11	Ergogrip grab rail 40cm polished ss, details anthracite
Article nr.	Ergogrip 500, length 50cm
LI2611.0501-02	Ergogrip grab rail 50cm white
LI2611.0501-11	Ergogrip grab rail 50cm anthracite
LI2611.0504-02	Ergogrip grab rail 50cm ss/white
LI2611.0502-00	Ergogrip grab rail 50cm polished ss, details white
LI2611.0502-11	Ergogrip grab rail 50cm polished ss, details anthracite
Article nr.	Ergogrip 600, length 60cm
LI2611.0601-02	Ergogrip grab rail 60cm white
LI2611.0601-11	Ergogrip grab rail 60cm anthracite
LI2611.0604-02	Ergogrip grab rail 60cm ss/white
LI2611.0602-00	Ergogrip grab rail 60cm polished ss, details white
LI2611.0602-11	Ergogrip grab rail 60cm polished ss, details anthracite
Article nr.	Ergogrip 700, length 70cm
LI2611.0701-02	Ergogrip grab rail 70cm white
LI2611.0701-11	Ergogrip grab rail 70cm anthracite
LI2611.0704-02	Ergogrip grab rail 70cm ss/white
LI2611.0702-00	Ergogrip grab rail 70cm polished ss, details white
LI2611.0702-11	Ergogrip grab rail 70cm polished ss, details anthracite

Article nr.	Ergogrip 800, length 80cm
LI2611.0801-02	Ergogrip grab rail 80cm white
LI2611.0801-11	Ergogrip grab rail 80cm anthracite
LI2611.0804-02	Ergogrip grab rail 80cm ss/white
LI2611.0802-00	Ergogrip grab rail 80cm polished ss, details white
LI2611.0802-11	Ergogrip grab rail 80cm polished ss, details anthracite
Article nr.	Ergogrip 900, length 90cm
LI2611.0901-02	Ergogrip grab rail 90cm white
LI2611.0901-11	Ergogrip grab rail 90cm anthracite
LI2611.0904-02	Ergogrip grab rail 90cm ss/white
LI2611.0902-00	Ergogrip grab rail 90cm polished ss, details white
LI2611.0902-11	Ergogrip grab rail 90cm polished ss, details anthracite
Article nr.	Ergogrip 1000, length 100cm
LI2611.1001-02	Ergogrip grab rail 100cm white
LI2611.1001-11	Ergogrip grab rail 100cm anthracite
LI2611.1004-02	Ergogrip grab rail 100cm ss/white
LI2611.1002-00	Ergogrip grab rail 100cm polished ss, details white
LI2611.1002-11	Ergogrip grab rail 100cm polished ss, details anthracite
Article nr.	Ergogrip 1200, length 120cm
LI2611.1201-02	Ergogrip grab rail 120cm white
LI2611.1201-11	Ergogrip grab rail 120cm anthracite
LI2611.1204-02	Ergogrip grab rail 120cm ss/white
LI2611.1202-00	Ergogrip grab rail 120cm polished ss, details white
LI2611.1202-11	Ergogrip grab rail 120cm polished ss, details anthracite
Article nr.	Ergogrip 1400, length 140cm
LI2611.1401-02	Ergogrip grab rail 140cm white
LI2611.1401-11	Ergogrip grab rail 140cm anthracite
LI2611.1404-02	Ergogrip grab rail 140cm ss/white
LI2611.1402-00	Ergogrip grab rail 140cm polished ss, details white
LI2611.1402-11	Ergogrip grab rail 140cm polished ss, details anthracite

Angled grab rail 45 degrees

Ergogrip 45 Small (A)

Ergogrip 45 Large (B)

- recommended for mounting beside toilet or bath
- mounting set LI2807.000 can be used (page 20)
- combine with backing plate LI0126.503 (page 20) when in doubt about strength of wall

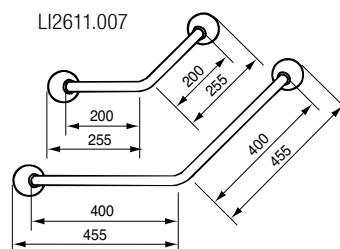

LI2611.008

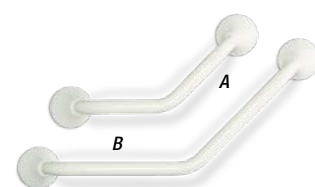

Article nr.	Description
LI2611.0071-02	Angled grab rail 45° 200x200mm white
LI2611.0071-11	Angled grab rail 45° 200x200mm anthracite
LI2611.0074-02	Angled grab rail 45° 200x200mm ss/white
LI2611.0072-00	Angled grab rail 45° 200x200mm polished ss, details white
LI2611.0072-11	Angled grab rail 45° 200x200mm polished ss, details anthracite

Article nr.	Description
LI2611.0081-02	Angled grab rail 45° 400x400mm white
LI2611.0081-11	Angled grab rail 45° 400x400mm anthracite
LI2611.0084-02	Angled grab rail 45° 400x400mm ss/white
LI2611.0082-00	Angled grab rail 45° 400x400mm polished ss, details white
LI2611.0082-11	Angled grab rail 45° 400x400mm polished ss, details anthracite

Grab rails

Horizontal angled grab rail

Ergogrip corner S

- for two walls
- use mounting set LI2807.000 (page 20)
(order 2 sets because of extra flange)
- combine with backing plate LI0126.503 (page 20)
when in doubt about strength of wall

Ideal to combine with our vertical combination grab rail LI2611.018 or LI2611.019 to form a sturdy shower rail, and shower holder LI2630.200 (page 19.)

NOTE: order vertical combination grab rail and shower holder separately

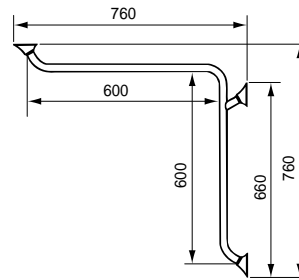

Article nr.	Description
LI2611.0151-02	Horizontal angled grab rail 600x600mm white
LI2611.0151-11	Horizontal angled grab rail 600x600mm anthracite
LI2611.0154-02	Horizontal angled grab rail 600x600mm ss/white
LI2611.0152-00	Horizontal angled grab rail 600x600mm polished ss, details white
LI2611.0152-11	Horizontal angled grab rail 600x600mm polished ss, details anthracite

Angled grab rail for two walls

Ergogrip corner L

- for two walls
- use mounting set LI2807.000 (page 20)
(order 2 sets because of extra flange)
- combine with backing plate LI0126.503 (page 20)
when in doubt about strength of wall

Ideal to combine with our vertical combination grab rail LI2611.018 or LI2611.019 to form a sturdy shower rail, and shower holder LI2630.200 (page 19.)

NOTE: order vertical combination grab rail and shower holder separately

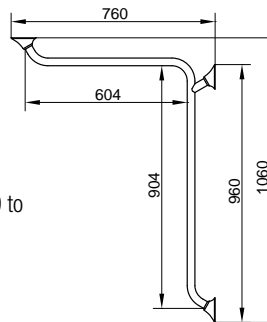

Article nr.	Description
LI2611.0251-02	Horizontal angled grab rail 600x900mm white
LI2611.0251-11	Horizontal angled grab rail 600x900mm anthracite
LI2611.0254-02	Horizontal angled grab rail 600x900mm ss/white
LI2611.0252-00	Horizontal angled grab rail 600x900mm polished ss, details white
LI2611.0252-11	Horizontal angled grab rail 600x900mm polished ss, details anthracite

Vertical combination grab rail

Ergogrip corner combination grab rail

- combine with any grab rails Ergogrip, 30cm or larger, to determine your own ideal set-up.
- combine with backing plate LI0126.503 (page 20)
when in doubt about strength of wall
- combined with a shower holder (LI2630.200) this combination grab rails also makes a sturdy shower rail!

NOTE: order shower holder (page 19) separately

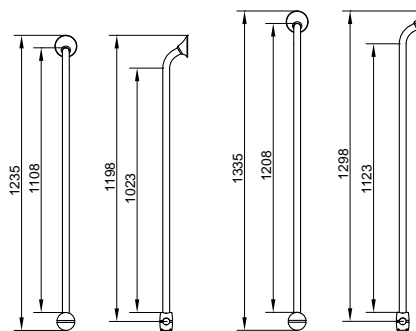

Article nr.	Description
LI2611.0184-02	Vertical combination grab rail 1235mm coated ss, white
LI2611.0184-11	Vertical combination grab rail 1235mm coated ss, anthracite
LI2611.0182-00	Vertical combination grab rail 1235mm polished ss, details white
LI2611.0182-11	Vertical combination grab rail 1235mm polished ss, details anthracite

Article nr.	Description
LI2611.0194-02	Vertical combination grab rail 1335mm coated ss, white
LI2611.0194-11	Vertical combination grab rail 1335mm coated ss, anthracite
LI2611.0192-00	Vertical combination grab rail 1335mm polished ss, details white
LI2611.0192-11	Vertical combination grab rail 1335mm polished ss, details anthracite

Grab rails

Angled grab rail 90 degrees

Ergogrip 90 left (A)

Ergogrip 90 right (B)

- recommended for mounting in bath and shower situations
- combined with a shower holder (LI2630.200) this grab rail also makes a sturdy shower rail!
- mounting set LI2807.000 (page 20) can be used (order 2x because of extra flange)
- combine with backing plate LI0126.503 (page 20) when in doubt about strength of wall

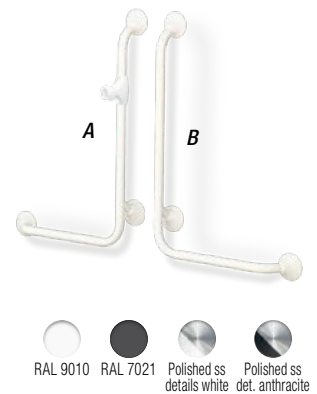
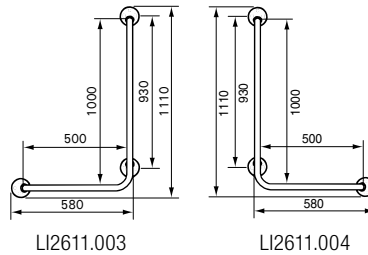

Article nr.	Description
LI2611.0031-02	Angled grab rails 90° 500x1000mm white
LI2611.0031-11	Angled grab rails 90° 500x1000mm anthracite
LI2611.0034-02	Angled grab rails 90° 500x1000mm ss/white
LI2611.0032-00	Angled grab rails 90° 500x1000mm polished ss, details white
LI2611.0032-11	Angled grab rails 90° 500x1000mm polished ss, details anthracite

A: Left

Article nr.	Description
LI2611.0041-02	Angled grab rails 90° 1000x500mm white
LI2611.0041-11	Angled grab rails 90° 1000x500mm anthracite
LI2611.0044-02	Angled grab rails 90° 1000x500mm ss/white
LI2611.0042-00	Angled grab rails 90° 1000x500mm polished ss, details white
LI2611.0042-11	Angled grab rails 90° 1000x500mm polished ss, details anthracite

B: Right

Angled grab rail 90 degrees

Ergogrip 90 left (A)

Ergogrip 90 right (B)

- recommended for mounting in bath and shower situations
- combined with a shower holder (LI2630.200) this grab rail also makes a sturdy shower rail!
- mounting set LI2807.000 (page 20) can be used (order 2x because of extra flange)
- combine with backing plate LI0126.503 (page 20) when in doubt about strength of wall

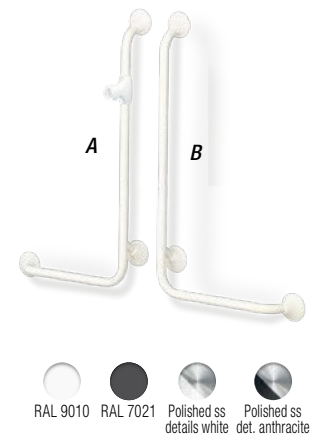
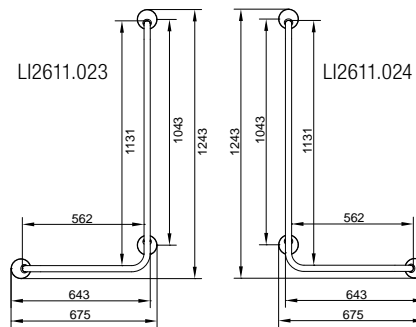

Article nr.	Description
LI2611.0231-02	Angled grab rails 90° 560x1130mm white
LI2611.0231-11	Angled grab rails 90° 560x1130mm anthracite
LI2611.0234-02	Angled grab rails 90° 560x1130mm ss/white
LI2611.0232-00	Angled grab rails 90° 560x1130mm polished ss, details white
LI2611.0232-11	Angled grab rails 90° 560x1130mm polished ss, details anthracite

A: Left

Article nr.	Description
LI2611.0241-02	Angled grab rails 90° 1130x560mm white
LI2611.0241-11	Angled grab rails 90° 1130x560mm anthracite
LI2611.0244-02	Angled grab rails 90° 1130x560mm ss/white
LI2611.0242-00	Angled grab rails 90° 1130x560mm polished ss, details white
LI2611.0242-11	Angled grab rails 90° 1130x560mm polished ss, details anthracite

B: Right

Shower head holder

- total plastic construction
- suitable for every Ergogrip grab rail from 30cm or more; converts an Ergogrip into a safe shower rail
- can also be fitted after installation of the Ergogrip grab rail
- light and easily adjustable over the full length of Ergogrip grab rail
- ergonomic grip
- for conical shaped collar of shower tube

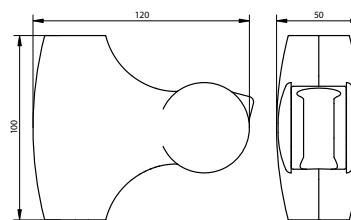

Article nr.	Description
LI2630.2006-02	Shower head holder white
LI2630.2006-11	Shower head holder anthracite



Grab rails

Towel rail

LI2637.001 (300mm) Towel rail Small
LI2637.002 (600mm) Towel rail Large

- combination of towel rail and grab rail
- top tube can be used as grab rail Ergogrip
- wall mounting set LI2807.000 can be used
- combine with backing plate LI0126.503 (see underneath) when in doubt about strength of wall

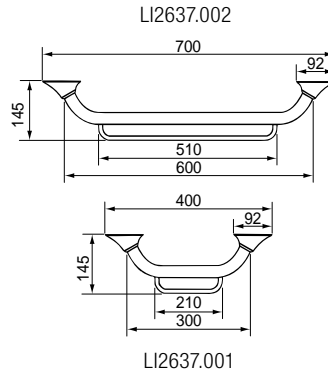

Article nr.	Description
LI2637.0011-02	Towel rail 300mm white
LI2637.0011-11	Towel rail 300mm anthracite
LI2637.0014-02	Towel rail 300mm ss/white
LI2637.0012-00	Towel rail 300mm polished ss, details white
LI2637.0012-11	Towel rail 300mm polished ss, details anthracite

Article nr.	Description
LI2637.0021-02	Towel rail 600mm white
LI2637.0021-11	Towel rail 600mm anthracite
LI2637.0024-02	Towel rail 600mm ss/white
LI2637.0022-00	Towel rail 600mm polished ss, details white
LI2637.0022-11	Towel rail 600mm polished ss, details anthracite

Backing plate round

- for fixing Ergogrip from rear of wall
- comes complete with nuts M6 welded on the plate and threaded studs, washers and nuts
- backing plate visible at back side of the wall
- only in white
- not suitable for system walls

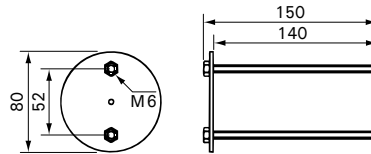

Article nr.	Description
LI0126.5034-02	CBacking plate grab rails ss/white

Wall mounting set

- for mounting of all Linido grab rails
- consisting of:
 - Fischer UX 8 plugs, 4 pieces;
 - lag screw, 6 x 60mm ss A2, 4 pieces
 - washer M8 DIN 125, ss A2, 4 pieces



Article nr.	Description
LI2807.000	Wall mounting set for grab rails

Stair newel grab rails

Stair newel grab rail A
Stair newel grab rail B

- for two walls (inner corner)

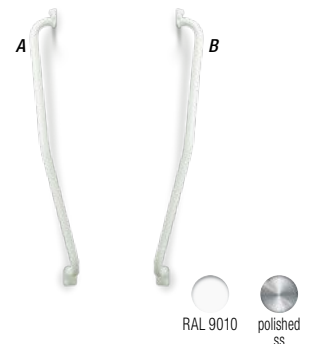
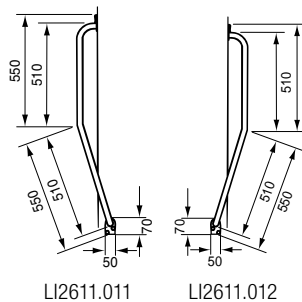

Article nr.	Description
LI2611.0111-02	Grab rail for stair newel A (newel on RH-side), white
LI2611.0114-02	Grab rail for stair newel A (newel on RH-side), ss/white
LI2611.0112-00	Grab rail for stair newel A (newel on RH-side), polished ss

Article nr.	Description
LI2611.0121-02	Grab rail for stair newel B (newel on LH-side), white
LI2611.0124-02	Grab rail for stair newel B (newel on LH-side), ss/white
LI2611.0122-00	Grab rail for stair newel B (newel on LH-side), polished ss

Grab rails

Door frame grab rails

Length =	A	B	C	D
LI2619.030	300	280	240	215
LI2619.045	450	430	390	365
LI2619.060	600	580	540	515

- the small flange makes this extremely suitable for mounting on doorframes
- diameter tube 22mm

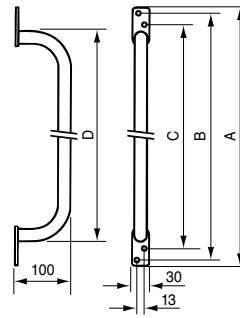

Article nr.	Description
LI2619.0301-02	Door frame grab rails 30cm white
LI2619.0451-02	Door frame grab rails 45cm white
LI2619.0601-02	Door frame grab rails 60cm white



Shower curtain rail

Shower curtain rail

- for corner shower
- without curtain and rings
- mounting set LI2807.000 (page 20) can be used
- combine with backing plate LI0126.503 (page 20) when in doubt about strength of wall

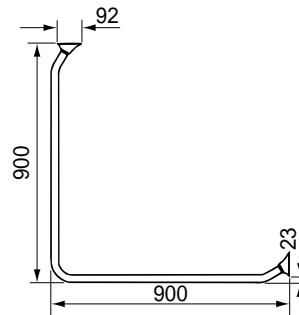

Article nr.	Description
LI2641.0001-02	Shower curtain rail 90° white
LI2641.0002-00	Shower curtain rail 90° polished ss, details white



Ceiling mounting set for shower curtain rail

- can be shortened to the desired height

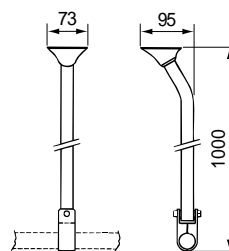

Article nr.	Description
LI2641.1003-02	Ceiling mounting kit white



Grab rails

Swinging support

- wall mounting
- can be operated by the user, from a lying position
- length of strap 1500mm
- can be locked at 0, 45, 90, 135 and 180 degrees
- length adjustable nylon strap and moulded grip

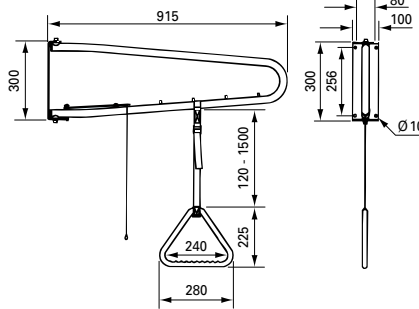

Article nr.	Description
LI2613.0001-02	Swinging support white

RAL 9010

Ceiling support

- ceiling mounting
- ceiling mounting plate with a length adjustable nylon strap and moulded grip

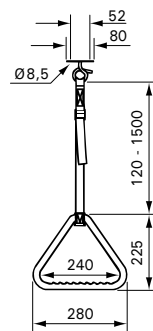

Article nr.	Description
LI2612.0001-02	Ceiling support white

RAL 9010

Grab rails

- aluminum with plastic
- anti-slip surface for extra safety
- tube diameter 32mm
- maximum user weight 130kg
- only available in white
- inclusive fixing materials
- 2 year guarantee
- not available in the USA

Article nr.	Description
2613012	Grab rail 305mm
2613016	Grab rail 406mm
2613018	Grab rail 457mm
2613024	Grab rail 610mm
2613036	Grab rail 915mm
2613042	Grab rail 1070mm

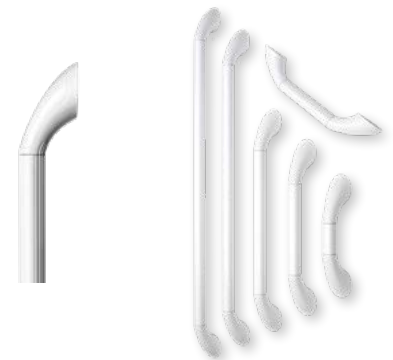

RAL 9010

Toilet aids



Extra support & comfort when using the toilet

A hinged arm support offers the user firm support when sitting down on the toilet and getting up again. It is also suitable to lean against when undressing or dressing. The arm support can be folded up after which it automatically locks. When folded up, the bracket can also give support when using the toilet standing up, or when cleaning the toilet. This unique support features a lateral load of 100 kg and a horizontal load of 150kg.

Fixed & hinged arm supports

Fixed arm supports

- loop shaped double tube makes forward transfer easier
- is always in the same position for additional security for the user
- lateral load 100kg; horizontal load 150kg.
- can also be used as addition to a shower seat when there is not enough space for shower seat with backrest and armrests or when a higher load than 100kg. for the armrest is desired
- fixing mount available (LI2806.000, page 12)

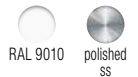
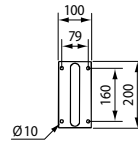
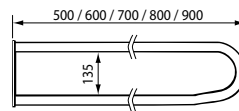

Article nr.	Fixed arm support, length 50cm
LI2601.0501-02	Fixed arm support 50cm, white
LI2601.0504-02	Fixed arm support 50cm, ss/white
LI2601.0502-00	Fixed arm support 50cm, polished ss
Fixed arm support, length 60cm	
LI2601.0601-02	Fixed arm support 60cm, white
LI2601.0604-02	Fixed arm support 60cm, ss/white
LI2601.0602-00	Fixed arm support 60cm, polished ss
Fixed arm support, length 70cm	
LI2601.0701-02	Fixed arm support 70cm, white
LI2601.0704-02	Fixed arm support 70cm, ss/white
LI2601.0702-00	Fixed arm support 70cm, polished ss

Fixed arm support, length 80cm	
LI2601.0801-02	Fixed arm support 80cm, white
LI2601.0804-02	Fixed arm support 80cm, ss/white
LI2601.0802-00	Fixed arm support 80cm, polished ss
Fixed arm support, length 90cm	
LI2601.0901-02	Fixed arm support 90cm, white
LI2601.0904-02	Fixed arm support 90cm, ss/white
LI2601.0902-00	Fixed arm support 90cm, polished ss
Wall mounting set	
LI2806.0000-00	Wall mounting set for LI2201 LI2601/03.

LI2806.000-00  4 pcs per set

Hinged arm supports

- offers support in both horizontal and vertical position
- locks automatically in the upright position
- can also be used as addition to a shower seat when there is not enough space for shower seat with backrest and armrests or when a higher load than 100kg. for the armrest is desired
- plastic wall plate with tube of coated steel, coated stainless steel or polished stainless steel
- fixing mount available (LI2806.000, page 12)

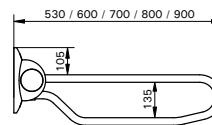
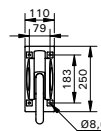

Article nr.	Hinged arm support, length 53cm
LI2603.3501-02	Hinged arm support 53cm white
LI2603.3501-11	Hinged arm support 53cm anthracite
LI2603.3504-02	Hinged arm support 53cm coated ss/white
LI2603.3502-02	Hinged arm support 53cm polished ss, details white
LI2603.3502-11	Hinged arm support 53cm polished ss, details anthracite
Hinged arm support, length 60cm	
LI2603.3601-02	Hinged arm support 60cm white
LI2603.3601-11	Hinged arm support 60cm anthracite
LI2603.3604-02	Hinged arm support 60cm coated ss/white
LI2603.3602-02	Hinged arm support 60cm polished ss, details white
LI2603.3602-11	Hinged arm support 60cm polished ss, details anthracite
Hinged arm support, length 70cm	
LI2603.3701-02	Hinged arm support 70cm white
LI2603.3701-11	Hinged arm support 70cm anthracite
LI2603.3704-02	Hinged arm support 70cm coated ss/white
LI2603.3702-02	Hinged arm support 70cm polished ss, details white
LI2603.3702-11	Hinged arm support 70cm polished ss, details anthracite

Hinged arm support, length 80cm	
LI2603.3801-02	Hinged arm support 80cm white
LI2603.3801-11	Hinged arm support 80cm anthracite
LI2603.3804-02	Hinged arm support 80cm coated ss/white
LI2603.3802-02	Hinged arm support 80cm polished ss, details white
LI2603.3802-11	Hinged arm support 80cm polished ss, details anthracite
Hinged arm support, length 90cm	
LI2603.3901-02	Hinged arm support 90cm white
LI2603.3901-11	Hinged arm support 90cm anthracite
LI2603.3904-02	Hinged arm support 90cm coated ss/white
LI2603.3902-02	Hinged arm support 90cm polished ss, details white
LI2603.3902-11	Hinged arm support 90cm polished ss, details anthracite
Wall mounting set	
LI2806.0000-00	Wall mounting set for LI2201 LI2601/03

LI2806.000-00  4 pcs per set

Fixed & hinged arm supports

Floor console for hinged arm support

- recommended when wall mounting of the hinged arm support is not possible or desirable
- including backing plate and aluminum clamps for mounting of hinged arm support
- once mounted on the floor console the hinged arm support can be readjusted

Article nr.	Description
LI2608.0001-02	Floor console + clamps white
LI2608.0001-11	Floor console + clamps anthracite
LI2608.0004-02	Floor console + clamps ss/white
LI2608.0002-02	Floor console + clamps polished ss

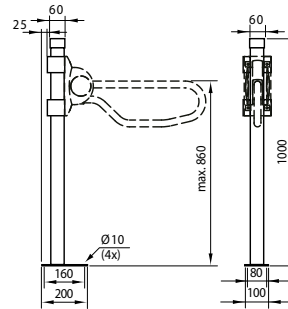

Floor support set for hinged arm support

- recommended if there is any doubt about the strength of the wall
- consists of adjustable floor support, clamps and distance stay
- smooth height adjustment for hinged arm support with height from floor to top of support from 700mm to 850mm
- can also be fitted after installation of the hinged arm support (LI2603.3xx)
- not applicable on LI2603.350
- maximum load: 150kg

NOTE: choice of material (stainless or steel) must match the material of the arm support

Article nr.	Description
LI2614.3001-02	Floor support set for hinged arm support white
LI2614.3001-11	Floor support set for hinged arm support anthracite
LI2614.3004-02	Floor support set for hinged arm support ss/white
LI2614.3002-00	Floor support set for hinged arm support polished ss

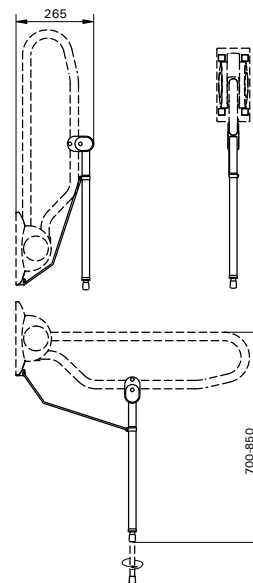

Screw cover sets

- to cover the mounting holes of the plastic wall plate of hinged arm supports **exclusively for** hinged arm support LI2603.3-series made **after august 2009**
- available in the colour of the wall plate
- included with our hinged arm supports

Article nr.	Description
LI2826.0036-02	Screw cover set hinged arm support white
LI2826.0036-11	Screw cover set hinged arm support anthracite

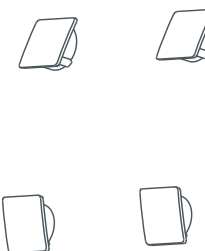

Pay attention when mounting



TIP

- Make sure the arm supports are mounted symmetrically to load the body of the user evenly.
- If you place only one toilet bracket, find out when the user needs support: is this specifically when sitting down or when getting up again, has the user a weaker arm, or has the user a diminished use of an arm?
- Make sure the arm support is protruding 15–20cm in front of the toilet. This causes the arm of the user to stay in a natural position when sitting down and getting up again.
- Choose an arm support in a contrasting colour when the user has impaired vision.

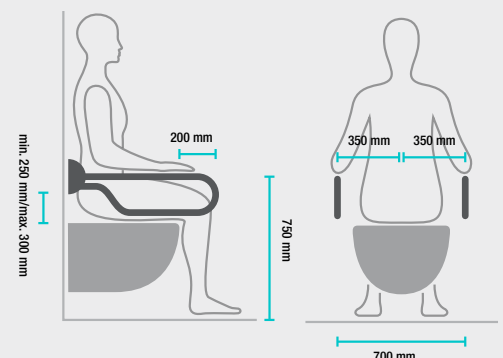

Fixed & hinged arm supports

Height adjustment system for hinged arm support

- can be used for hinged arm supports LI2603.3xx
- smooth height adjustment to required height of support
- allows mounting of hinged arm at a later stage
- range in adjustment 150mm
- set adjustable clamp levers available (LI2815.001)

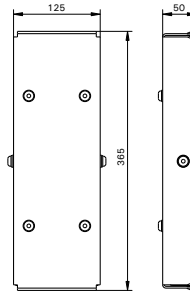

RAL 9010

Article nr.	Description
LI2615.3004-02	Height adjustment system for 2603.3xx ss/white

Set adjustable clamp levers

- To be used with height adjustment system LI2615.3004-02. 2 pieces, black plastic.



Article nr.	Description
LI2815.0010-00	Set of 2 adjustable clamp levers for LI2615.3004-02

Soft armrest

Soft armrest

- fits all Linido hinged arm supports (LI2603.3xx)
(**NOT for polished version**)
- including adhesive
- only in black

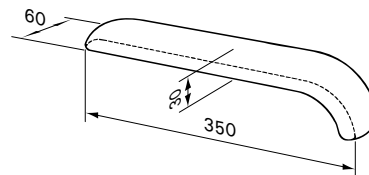

Article nr.	Description
LI2610.0010-00	Polyurethane foam soft armrest 28mm, incl. glue set

Front support bar

- applicable as front support or as fixation in combination with two fixed arm supports (LI2601.0xx) or two hinged arm supports (LI2603.3xx)
- can be fitted in new and existing situations
- depth adjustable, lock on one side
- foam with ergonomic shape; washable, resistant to heavy use
- easy to assemble

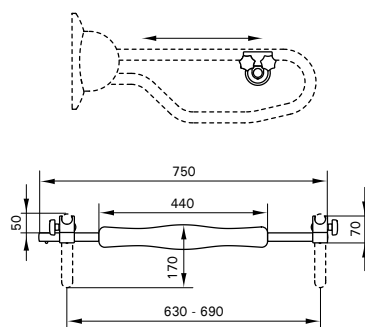

Article nr.	Description
LI2609.2003-02	Front support bar, white aluminum.

Fixed & hinged arm supports

Backing plate rectangular

- for fixing hinged arm support from rear of wall
- comes complete with welded nuts M8 and matching threaded studs, washers and nuts
- backing plate visible at back side of the wall
- only in white
- not suitable for fixed arm supports

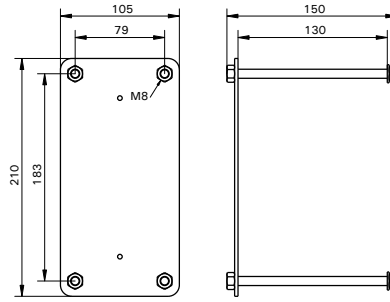

Article nr.	Description
LI0126.5014-02	Backing plate for hinged arm support ss/white

Toilet roll holder

- polished stainless steel roll holder with black plastic clamp for mounting onto Linido hinged arm support (LI2603.3xx), fixed arm support (LI2601.0xx) or Ergogrip grab rail (LI2611.xxx)

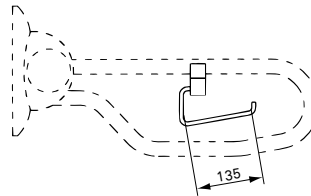

Article nr.	Description
LI2617.0002-03	Toilet roll holder with clamp, ss/black

Toilet roll holder single-hand

- plastic toilet roll holder, which makes it possible to change, unroll and tear the toilet paper with one hand
- fits any Linido hinged arm support (LI2603.3xx), fixed arm support (LI2601.0xx) or any Ergogrip grab rail (LI2611.xxx) larger than 40cm. **(applicable only to steel-coated versions)**
- only in white

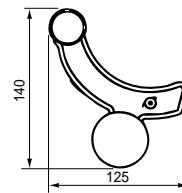
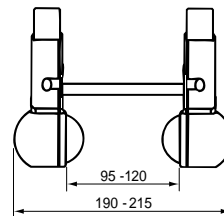

Article nr.	Description
LI2618.0006-02	Toilet roll holder for single-handed use, white

Toilet brush and holder

- total plastic construction
- including stainless steel fixings

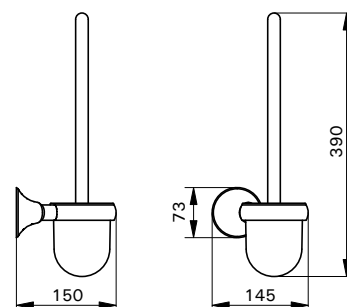

Article nr.	Description
LI2631.0006-02	Toilet brush and holder, white

RAL 9010

Direct Healthcare Group Demo Case

The better you can meet the needs of your customer, the greater the chance that you get the order. One of these needs is experiencing a product.

We have developed a case with the best-selling Direct Healthcare Group bathroom aids that you can take along on customer visits.

Ask your contact person for more information or contact our Customer Service.



Article nr.	Description
LI9960.040	Direct Healthcare Group demo case



Toilet aids

Spare toilet roll holder

- total plastic construction
- can also be used as spare roll holder
- including stainless steel fixings

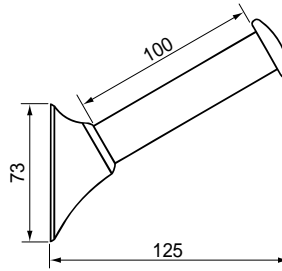

Article nr.	Description
LI2635.0006-02	Spare toilet roll holder for wall mounting, white



Backrest

- for wall fixing behind a toilet with a high level cistern
- the user can lean backwards in safety and comfort
- flexible and depth adjustable
- backrest cushion in the colour graphite

	A
LI2701.200	195 - 250
LI2703.200	280 - 415

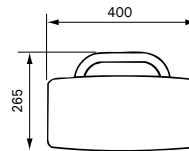

Article nr.	Description
LI2701.2004-02	Backrest short, ss/white
LI2703.2004-02	Backrest long, ss/white

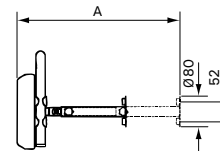

Backrest for built-in cistern

- for wall fixing behind a toilet with a built-in cistern
- the user can lean backwards in safety and comfort
- flexible and depth adjustable
- backrest cushion in the colour graphite

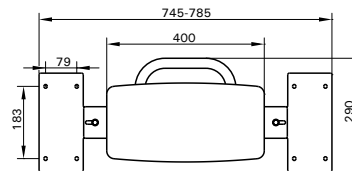

Article nr.	Description
LI2705.2004-02	Backrest for built-in cistern

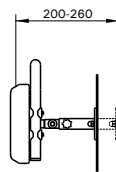

Comfort-seat

- soft toilet seat for people who need to sit on the toilet for a longer time and/or have a sensitive skin
- two kinds of foam under a waterproof coating
- including stainless steel fixing material
- only available in graphite

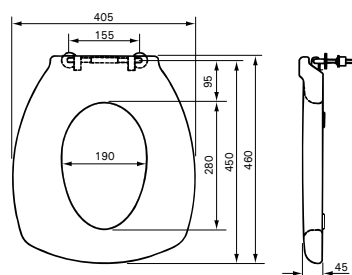

Article nr.	Description
LI09506.316	Comfort-Seat

Toilet aids

Toilet raiser with lid

- increases the seat height of a toilet by 100mm/4"
- fits most standard-size toilets
- easy to install, no tools needed
- only available in white
- max. user weight: 130kg
- guarantee 2 years
- not available in the USA

Article nr.	Description
10735	Toilet raiser with lid, 100mm



Toilet raiser with armrests and lid

- increases the seat height of a toilet by 85mm/3.35", 125mm/4.92" or 165mm/6.5"
 - removable, independent, swivel armrests
 - fits most standard-size toilets
 - easy to install, no tools needed
 - includes standard toilet seat and lid
 - only available in white
 - max. user weight: 130kg
 - guarantee 2 years
 - not available in the USA
- ⚠ not suitable for lateral transfers. If desired, we recommend fitting hinged armrests (LI2603.3xx) next to the toilet.

Article nr.	Description
10659	Toilet raiser with armrests and lid



Armrests with floor support

- aluminum frame with plastic armrests
- adjustable height
- easy to install, for travel or temporary use
- max. user weight: 100kg
- guarantee 2 years
- not available in the USA

Article nr.	Description
10540	Armrests with floor support



Washbasin aids



Making everyday life easier

Solutions around the washbasin designed to encourage independent functioning, like adjustable height for wheelchair users. When a person in a wheelchair independently uses the toilet or shower, it is important that he or she can reach everywhere, has support where it is needed and that there is sufficient room to manoeuvre.

Washbasin aids

Washbasin adjustment system

- for smooth height and depth adjustment of washbasin by means of a gas spring
- adjustment range: 250mm in height and 86mm in depth
- easy mounting at any desired height
- suitable for all standard washbasins with a flat back and a weight of 15–18kg
- easy operation by means of a handle
- supplied without washbasin, tap and flexible hoses
- only in white

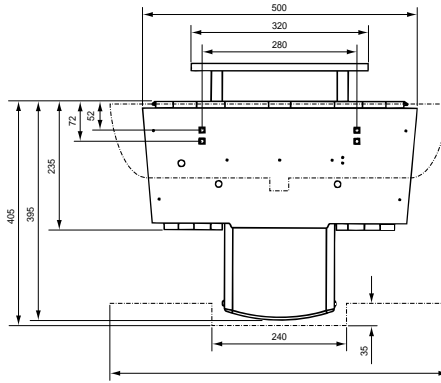

Article nr.	Description
LI3012.0004-02	Washbasin adjustment system

Flexible supply and drain kit

- flexible supply and drain set Ø 40mm, includes the washbasin plug, for standard washbasin and washbasin unit LI3012.000
- flexible hose 150cm
- two 50cm long flexible hoses clad with stainless steel are supplied for attaching to hot and cold water supply and have 3/8" and 10mm connectors
- drain can be mounted horizontally or vertically
- only in white



Article nr.	Description
LI3013.0000-00	Flexible supply & drain kit

Washbasin rail

- offers support around the washbasin
- screw caps included
- Mounting kit is not supplied, what to use depends on the wall situation
- only in white

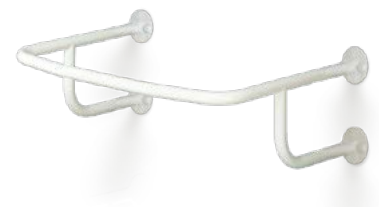
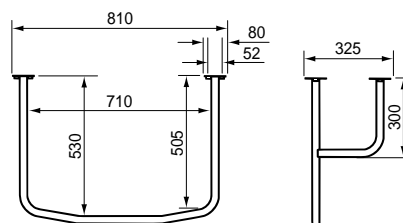

Article nr.	Description
LI2606.0001-02	Washbasin rail white

RAL 9010

Washbasin rail with grab handles

- the washbasin rail with grab handles offers solid grip to stand up near the washbasin and provides support at a height that is comfortable during standing
- a user is standing closer to the mirror, which makes tasks like shaving and hair combing easier
- a sink bracket also prevents users from overloading the ceramic washbasin
- only in white

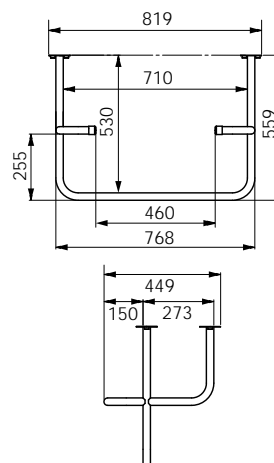

Article nr.	Description
LI2606.0011-02	Washbasin rail with grab handles, white

RAL 9010

Washbasin aids

Hardware for tilting mirror

- can also be used as a grab rail (400mm)
- fixings for putting in a mirror of your own choice
- will be delivered without mirror
- Advice for measurements of mirror:
Round: max. Ø 60cm
Rectangular: max. 60 x 40cm
Thickness: max. 6mm

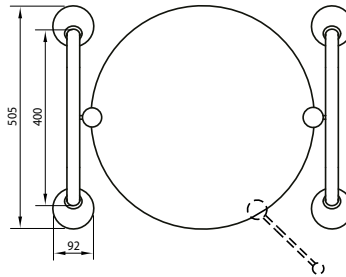

Article nr.	Description
LI2642.0011-02	Hardware for tilting mirror white
LI2642.0011-11	Hardware for tilting mirror anthracite
LI2642.0014-02	Hardware for tilting mirror ss/white
LI2642.0012-02	Hardware for tilting mirror polished ss, details white
LI2642.0012-11	Hardware for tilting mirror polished ss, details anthracite



Handle for tilting mirror

- handle for tilting mirror

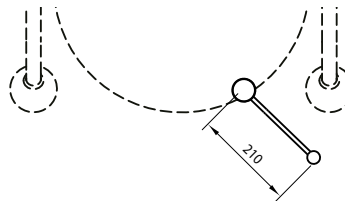

Article nr.	Description
LI2642.0022-02	Handle for tilting mirror ss/white, black knob
LI2642.0022-11	Handle for tilting mirror ss/anthracite, black knob

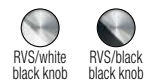

Shelf

- plastic shelf
- including stainless steel fixings

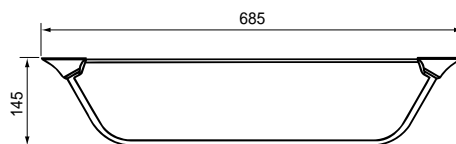

Article nr.	Description
LI2634.0001-02	Shelf white
LI2634.0004-02	Shelf ss/white
LI2634.0002-02	Shelf polished ss



Bathroom accessories

Tooth brush holder

- total plastic construction
- including transparent tumbler
- including stainless steel fixings

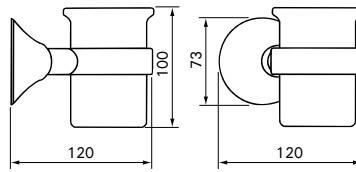

Article nr.	Description
LI2632.0006-02	Tooth brush holder white



Soap dish

- total plastic construction
- including stainless steel fixings

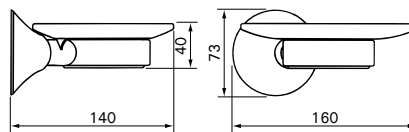

Article nr.	Description
LI2633.0006-02	Soap dish white



Robe hooks

- Robe hook single*
- Robe hook double*

- total plastic construction
- including stainless steel fixings

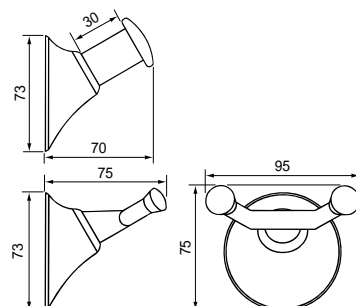

Article nr.	Description
LI2636.0006-02	Robe hook single, white
LI2636.0016-02	Robe hook double, white



Bath aids & shower stretchers



Making everyday life easier

Solutions around the bath for safely stepping in and out of the bath and showering sitting down. They help maintain the independence of the user. Shower stretchers are an excellent solution for showering a passive client in a lying position and offer the carer a good posture to avoid unnecessary loads. Our bath aids are easy to clean and have a high safe working load.

Shower stretchers

Shower stretcher

- HT-cover* material
- hinges to the wall (folds up or folds down)
- hinged leg supports
- including wall clamp to secure stretcher when folded up against the wall
- suitable for users with a body weight up to 150kg

	A	B
LI2403.150	1490	185
LI2403.170	1690	285
LI2403.190	1890	385

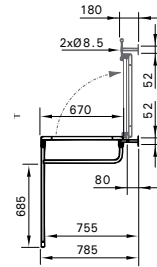
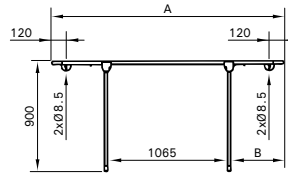

LI2807.000-00  4 pcs per set

Article nr.	Description	
LI2403.1501-02	Shower stretcher, coated steel white	length 150cm
LI2403.1504-02	Shower stretcher, coated ss white	length 150cm
LI2403.1701-02	Shower stretcher, coated steel white	length 170cm
LI2403.1704-02	Shower stretcher, coated ss white	length 170cm
LI2403.1901-02	Shower stretcher, coated steel white	length 190cm
LI2403.1904-02	Shower stretcher, coated ss white	length 190cm
LI2807.000-00	Wall mounting set	

Shower stretcher with adjustable backrest

- HT-cover* material
- hinges to the wall (folds up or folds down)
- hinged leg supports
- including wall clamp to secure stretcher when folded up against the wall
- available with adjustable backrest by means of a gas spring and with pvc water receiver and flexible drain hose
- suitable for users with a body weight up to 150kg

	A	B	C
LI2408.150	1520	465	200
LI2408.170	1720	615	300
LI2408.190	1920	615	400

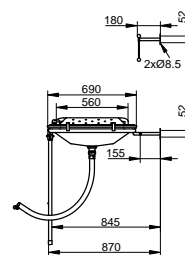
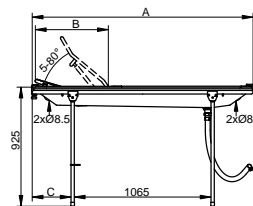

LI2807.000-00  4 pcs per set

Article nr.	Description	
LI2408.1501-02	Shower stretcher w. adj. backrest, coated steel white	length 150cm
LI2408.1504-02	Shower stretcher w. adj. backrest, coated ss white	length 150cm
LI2408.1701-02	Shower stretcher w. adj. backrest, coated steel white	length 170cm
LI2408.1704-02	Shower stretcher w. adj. backrest, coated ss white	length 170cm
LI2408.1901-02	Shower stretcher w. adj. backrest, coated steel white	length 190cm
LI2408.1904-02	Shower stretcher w. adj. backrest, coated ss white	length 190cm
LI2807.000-00	Wall mounting set	

Removable side fence

- suitable for all Linido shower stretchers and shower trolleys
- including plastic mounting clamps

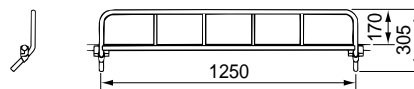

Article nr.	Description	
LI2490.1251-02	Removable side fence, coated steel white	length 1250mm
LI2490.1254-02	Removable side fence, coated ss white	length 1250mm



Please find specifications, technical drawings, dimensions and documentation of our products on www.directhealthcaregroup.com

TIP

Bath accessories

Bathboard

- easy to install and easy to move, without damage or permanent changes
- seat depth 300–350mm
- adjustable width, 410–625mm/16.1"–24.6"
- fits bathtubs with an inner width of up to 625mm/24.6"
- well spaced drainage holes
- easy to clean
- max. user weight up to 150kg
- 2 year guarantee
- not available in the USA



Article nr.	Description
12180	Bathboard



Maintenance instructions for bathroom adaptations

Maintenance, washing and cleaning instructions

Washing, cleaning and maintaining aids is a necessity not only for hygiene and safety, but also for prevention of infections. Below, you will find general information on maintaining our products. For more information, read the instructions in the manuals. Our products are constantly being further developed and improved; therefore we reserve the right to modify products without prior notification. The most recent information is always available on our website: www.directhealthcaregroup.com.

Maintenance before and during use

Direct Healthcare Group advises to inspect the product regularly on the following points:

- Make sure that the product is properly installed and/or assembled.
- Make sure all screws and bolts are tightened properly.
- Make sure clips are in the right position and can safely perform their duties.
- Regularly check that all the components are in place and properly tightened.
- Check for possible damage.

Daily cleaning

1. For optimal hygiene it is recommended to rinse the product immediately after use with hot water or a mild soap solution (PH 6–8).
We recommend not to use chlorine, solvents, abrasive or aggressive cleaning agents, as this can cause discolouration of the coating, PUR- and plastic parts, or even may cause damage the material itself. Some parts, such as a seat or bedpan can be removed or folded to facilitate easy cleaning. It is important that these parts are put back correctly.
2. After rinsing, the product should be wiped with a clean, damp, soft cloth. The rinse and wipe ensures that soap and secretions are removed immediately and so avoid the risk of bacteria growth.
3. Allow the product to dry, preferably in a well ventilated area, before it is used again.







Disinfection

The product should be disinfected according to the protocol of the facility with regard to method, duration and frequency.

Below are the general guidelines from Direct Healthcare Group:

The products, including the polyurethane parts, can tolerate temperatures up to 85°C for three minutes. Alternate options are: 90°C for one minute or 80°C for ten minutes.

The disinfectants that have been approved by the local healthcare authorities may be used for disinfection. A 70% ethanol solution, 45% isopropanol solution or something comparable can be used without problems.

 85°C 185°F	 3 min
 90°C 194°F	 1 min
 80°C 176°F	 10 min

Reuse

If the product is reused or used for a new client, defective or worn parts must be replaced. Disinfection of the product as described above is necessary.

Recycling

When the product has reached its technical lifespan, the product must be disposed of in parts. The plastic parts can be sorted as residual waste. Metal parts should be treated as metal waste for optimal recycling.



Commode/shower chairs, shower stools



Hassle-free daily care

Direct Healthcare Group commode/shower chairs and stools provide a stable starting position while showering, toileting and related (self) care activities. Special features of the commode/shower chairs is the soft toilet seat which makes it possible to use the chair for toileting above a toilet or on the chair in combination with a bucket or bedpan. In addition, the seat is suitable for use in the shower or by a washbasin. Our chairs are equipped with a comfortable seat, a backrest and practical ergonomic armrests, and are easy to manoeuvre.

Commode/shower chairs

Tilting commode/shower chair

- independent swivel armrests, ergonomic shape
- four double braked castors Ø 125mm
- backrest HT-cover* material
- adjustable and removable swing away footrests
- hinged soft toilet seat with open front
- removable rails for bedpan Ø 300–315mm
- 30° tilting operation by gas spring
- height and depth adjustable headrest
- calf strap and lumbar support
- can be placed over toilet (max. height 450mm)

* = Hygiene & Transfer: coated woven polyester textile

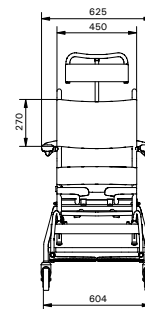
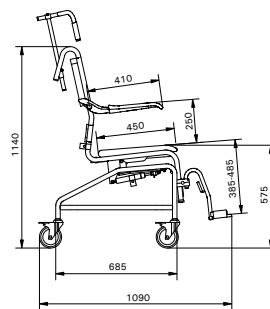

LI2150.0214-02

Article nr.	Description	
LI2150.0214-02	Tilting commode/shower chair, coated ss white	toilet seat open front
LI2135.0212-00	Tilting commode/shower chair, polished ss	toilet seat open front
Option 106	Custom made soft toilet seat (additional charge)	
Option 107	Custom made soft toilet seat (ordered separately)	
LI02979.411	Bedpan, incl. lid	stainless Ø 300mm

Height adjustable/tilting commode/shower chair

- independent swivel armrests, ergonomic shape
- four double braked castors Ø 125mm
- backrest HT-cover* material
- adjustable and removable swing-away stainless steel footrests
- detachable and reversible soft toilet seat: hygiene opening at front or back at choice, order insert LI09506.636 separately
- removable rails for bucket Ø 300–315mm
- electrical control for adjustment of seat height from 580 to 1040mm
- electrical control for smooth tilt, max. 35°
- safety belt, lumbar support and calf strap included
- height and depth adjustable headrest
- can be placed over toilet

* = Hygiene & Transfer: coated woven polyester textile

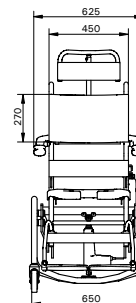
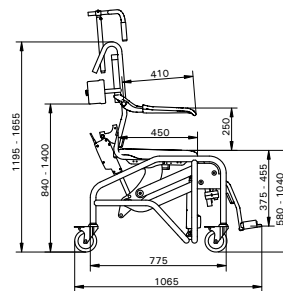

LI2161.3214-02

Article nr.	Description	
LI2161.1214-02	Height adjustable/tilting commode/shower chair, coated ss white	hydraulic adjustment
LI2161.1212-00	Height adjustable/tilting commode/shower chair, polished ss	hydraulic adjustment
LI2161.3214-02	Height adjustable/tilting commode/shower chair, coated ss white	electrical adjustment
LI2161.3212-00	Height adjustable/tilting commode/shower chair, polished ss	electrical adjustment
Option 106	Custom made soft toilet seat (additional charge)	
Option 107	Custom made soft toilet seat (ordered separately)	
LI02979.430	Bucket	stainless Ø 300mm

Mobile commode/shower chair heavy duty

- frame: width 600mm, depth 500mm
- reinforced frame
- maximum user weight: 300kg
- flip-down locking armrests
- backrest HT-cover* material
- hinged soft toilet seat with open front
- rails for bedpan and bucket Ø 300–315mm
- four double braked castors Ø 125mm
- adjustable swing-up footrest
- only available with hygiene opening at front of seat

* = Hygiene & Transfer: coated woven polyester textile

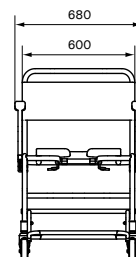
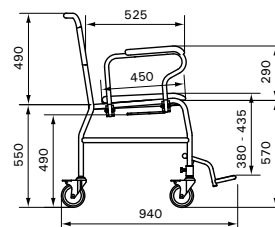

LI2137.5211-02

Article nr.	Description	
LI2137.5211-02	Mobile commode/shower chair heavy duty, coated steel white	toilet seat open front
LI2137.5214-02	Mobile commode/shower chair heavy duty, coated ss white	toilet seat open front

Commode/shower chairs

Commode/shower chair

- independent swivel armrests, ergonomic shape
- backrest HT-cover* material = Hygiene & Transfer: coated woven polyester textile
- hinged soft toilet seat with open or closed front
- rails for bedpan and bucket Ø 300–315mm
- seat height LI2135.011/021 is 610mm
- seat height LI2135.111/121 is 530mm

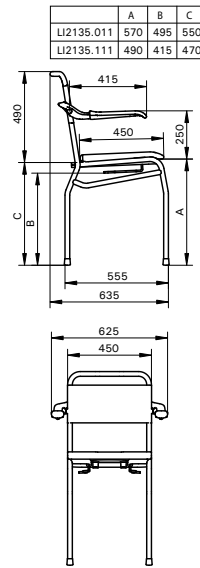

LI2135.1211-02

	Article nr.	Description	
seat height 610mm	LI2135.0111-02	Coated steel white	toilet seat with closed front
	LI2135.0211-02	Coated steel white	toilet seat with open front
	LI2135.0114-02	Coated ss white	toilet seat with closed front
	LI2135.0214-02	Coated ss white	toilet seat with open front
	LI2135.0112-00	Polished ss	toilet seat with closed front
seat height 530mm	LI2135.0212-00	Polished ss	toilet seat with open front
	LI2135.1111-02	Coated steel white	toilet seat with closed front
	LI2135.1211-02	Coated steel white	toilet seat with open front
	LI2135.1114-02	Coated ss white	toilet seat with closed front
	LI2135.1214-02	Coated ss white	toilet seat with open front
	LI2135.1112-00	Polished ss	toilet seat with closed front
	LI2135.1212-00	Polished ss	toilet seat with open front

Mobile commode/shower chair

- independent swivel armrests, ergonomic shape
- backrest HT-cover* material = Hygiene & Transfer: coated woven polyester textile
- hinged soft toilet seat with open or closed front
- rails for bedpan and bucket Ø 300–315mm
- four double braked castors Ø 125mm
- seat height LI2136.011/021 is 610mm
- seat height LI2136.111/121 is 530mm

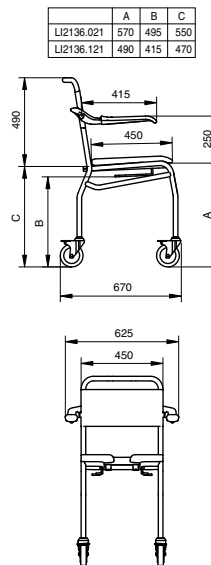

LI2136.0111-02

	Article nr.	Description	
seat height 610mm	LI2136.0111-02	Coated steel white	toilet seat with closed front
	LI2136.0211-02	Coated steel white	toilet seat with open front
	LI2136.0114-02	Coated ss white	toilet seat with closed front
	LI2136.0214-02	Coated ss white	toilet seat with open front
	LI2136.0112-00	Polished ss	toilet seat with closed front
seat height 530mm	LI2136.0212-00	Polished ss	toilet seat with open front
	LI2136.1111-02	Coated steel white	toilet seat with closed front
	LI2136.1211-02	Coated steel white	toilet seat with open front
	LI2136.1114-02	Coated ss white	toilet seat with closed front
	LI2136.1214-02	Coated ss white	toilet seat with open front
	LI2136.1112-00	Polished ss	toilet seat with closed front
	LI2136.1212-00	Polished ss	toilet seat with open front

Mobile commode/shower chair

- independent swivel armrests, ergonomic shape
- backrest HT-cover* material = Hygiene & Transfer: coated woven polyester textile
- hinged soft toilet seat with open or closed front
- rails for bedpan and bucket Ø 300–315mm
- four double braked castors Ø 125mm
- adjustable swing-up footrests
- seat height LI2137.011/021 is 610mm
- seat height LI2137.111/121 is 530mm

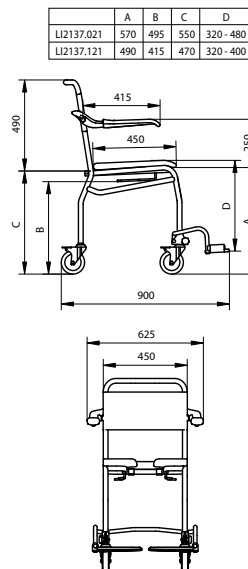

LI2137.0211-02

	Article nr.	Description	
seat height 610mm	LI2137.0111-02	Coated steel white	toilet seat with closed front
	LI2137.0211-02	Coated steel white	toilet seat with open front
	LI2137.0114-02	Coated ss white	toilet seat with closed front
	LI2137.0214-02	Coated ss white	toilet seat with open front
	LI2137.0112-00	Polished ss	toilet seat with closed front
seat height 530mm	LI2137.0212-00	Polished ss	toilet seat with open front
	LI2137.1111-02	Coated steel white	toilet seat with closed front
	LI2137.1211-02	Coated steel white	toilet seat with open front
	LI2137.1114-02	Coated ss white	toilet seat with closed front
	LI2137.1214-02	Coated ss white	toilet seat with open front
	LI2137.1112-00	Polished ss	toilet seat with closed front
	LI2137.1212-00	Polished ss	toilet seat with open front

Commode/shower chairs

Commode/shower chair (self propelling)

- independent swivel armrests, ergonomic shape
- backrest HT-cover* material
 - = Hygiene & Transfer: coated woven polyester textile
- hinged soft toilet seat with open or closed front
- distance from wall – centre toilet opening: 545mm
- rails for bedpan and bucket Ø 300–315mm
- double braked castors Ø 125mm and moulded 24" wheels with brake and rim
- adjustable swing-up footrests
- seat height LI2138.011/021 is 610mm
- seat height LI2138.111/121 is 530mm

	A	B	C	D
LI2138.021	570	495	550	320-480
LI2138.121	490	415	470	320-400

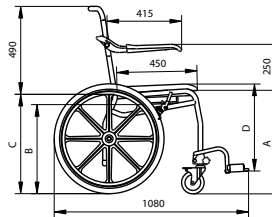

LI2138.1211-02

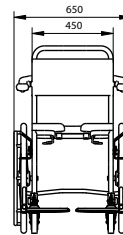

Article nr.	Description	
LI2138.0111-02	Coated steel white	toilet seat with closed front
LI2138.0211-02	Coated steel white	toilet seat with open front
LI2138.0114-02	Coated ss white	toilet seat with closed front
LI2138.0214-02	Coated ss white	toilet seat with open front
LI2138.0112-00	Polished ss	toilet seat with closed front
LI2138.0212-00	Polished ss	toilet seat with open front
seat height 610mm		
LI2138.1111-02	Coated steel white	toilet seat with closed front
LI2138.1211-02	Coated steel white	toilet seat with open front
LI2138.1114-02	Coated ss white	toilet seat with closed front
LI2138.1214-02	Coated ss white	toilet seat with open front
LI2138.1112-00	Polished ss	toilet seat with closed front
LI2138.1212-00	Polished ss	toilet seat with open front
seat height 530mm		

Soft toilet seats

LI0121.904 soft toilet seat with open front

LI0121.905 soft toilet seat with closed front

- Linido soft toilet seats will fit all Linido commode/shower chairs except LI2161.121, LI2161.321, LI2137.521 and Combi chairs
- polyurethane foam (graphite)
- guarantee 1 year

LI09506.306

insert for soft toilet seat

- only for the above-mentioned soft toilet seats
- polyurethane foam (graphite)
- guarantee 1 year

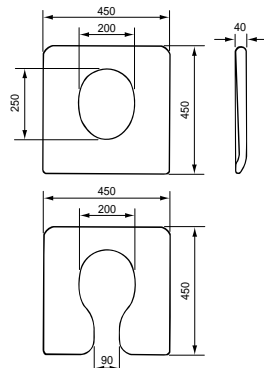

Article nr.	Description	
LI0121.904-00	Soft toilet seat with open front	polyurethane foam (graphite)
LI0121.9050-00	Soft toilet seat with closed front	polyurethane foam (graphite)
LI09506.306	Insert for soft toilet seat	polyurethane foam (graphite)

Bedpan & bucket

Bedpan LI02979.411

- stainless steel, Ø 300mm
- with lid and handle

Bucket LI02979.430

- stainless steel, Ø 300mm
- with lid and handle

Article nr.	Description	
LI02979.411	Bedpan, incl. lid	stainless steel Ø 300mm
LI02979.430	Bucket	stainless steel Ø 300mm



Commode/shower chairs

Neoprene seat for shower/toilet chairs

Custom made soft toilet seat for more comfort, will fit all Linido shower/toilet chairs except LI2137.521 and Combi chairs. Guarantee 1 year

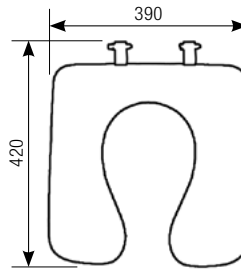

This is a sample, dimensions may vary

Article nr.	Description
Option 106	Custom made soft toilet seat (additional charge)
Option 107	Custom made soft toilet seat (ordered separately)

Foldable toilet frame with back support

- aluminum frame with plastic seat & backrest
- easy to install, for travel or temporary use
- max. user weight: 100kg
- 2 year guarantee
- not available in the USA



Article nr.	Description
10498	Foldable toilet frame with back support

Foldable toilet frame

- aluminum frame with plastic seat & backrest
- easy to install, for travel or temporary use
- max. user weight: 100kg
- 2 year guarantee
- not available in the USA



Article nr.	Description
10499	Foldable toilet frame

Shower chairs

Shower chair

- seat and backrest HT-cover* material
- independent swivel armrests, ergonomic shape

* = Hygiene & Transfer: coated woven polyester textile

Article nr.	Description	
LI2139.0001-02	Shower chair, coated steel white	seat height 540mm
LI2139.0004-02	Shower chair, coated ss white	seat height 540mm
LI2139.0002-00	Shower chair, polished ss	seat height 540mm
LI2139.1001-02	Shower chair, coated steel white	seat height 490mm
LI2139.1004-02	Shower chair, coated ss white	seat height 490mm
LI2139.1002-00	Shower chair, polished ss	seat height 490mm

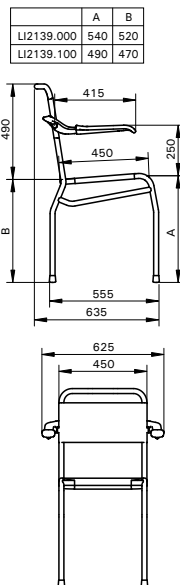

LI2139.1001-02

Mobile shower chair

- seat and backrest HT-cover* material
- independent swivel armrests, ergonomic shape
- four double braked castors Ø 125mm

* = Hygiene & Transfer: coated woven polyester textile

Article nr.	Description	
LI2140.0001-02	Shower chair, coated steel white	seat height 540mm
LI2140.0004-02	Shower chair, coated ss white	seat height 540mm
LI2140.0002-00	Shower chair, polished ss	seat height 540mm
LI2140.1001-02	Shower chair, coated steel white	seat height 490mm
LI2140.1004-02	Shower chair, coated ss white	seat height 490mm
LI2140.1002-00	Shower chair, polished ss	seat height 490mm

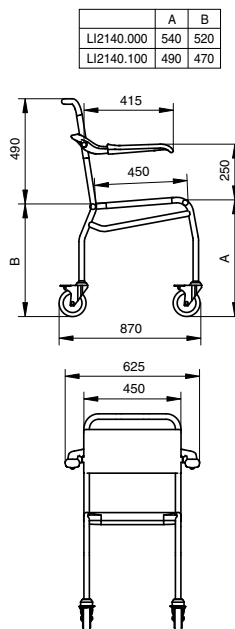

LI2140.1001-02

Mobile shower chair

- seat and backrest HT-cover* material
- independent swivel armrests, ergonomic shape
- four double braked castors Ø 125mm
- adjustable swing-up footrests

* = Hygiene & Transfer: coated woven polyester textile

Article nr.	Description	
LI2141.0001-02	Shower chair, coated steel white	seat height 540mm
LI2141.0004-02	Shower chair, coated ss white	seat height 540mm
LI2141.0002-00	Shower chair, polished ss	seat height 540mm
LI2141.1001-02	Shower chair, coated steel white	seat height 490mm
LI2141.1004-02	Shower chair, coated ss white	seat height 490mm
LI2141.1002-00	Shower chair, polished ss	seat height 490mm

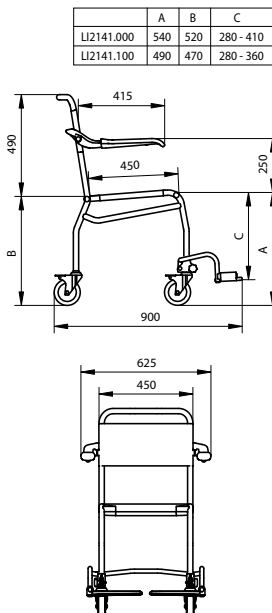

LI2141.1001-02

Shower chairs

Shower chair (self propelling)

- seat and backrest HT-cover* material
- independent swivel armrests, ergonomic shape
- double braked castors Ø 125mm and moulded 24" wheels with brake and rim
- adjustable swing-up footrests

* = Hygiene & Transfer: coated woven polyester textile

	A	B	C
LI2142.000	540	520	280-410
LI2142.100	490	470	280-360

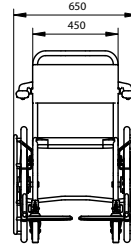
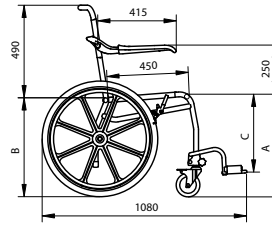

LI2142.1001-02

Article nr.	Description	
LI2142.0001-02	Shower chair (self propelling), coated steel white	seat height 540mm
LI2142.0004-02	Shower chair (self propelling), coated ss white	seat height 540mm
LI2142.0002-00	Shower chair (self propelling), polished ss	seat height 540mm
LI2142.1001-02	Shower chair (self propelling), coated steel white	seat height 490mm
LI2142.1004-02	Shower chair (self propelling), coated ss white	seat height 490mm
LI2142.1002-00	Shower chair (self propelling), polished ss	seat height 490mm



Shower stools

Shower stool soft seat

- soft, removable seat with water permeable slots
- continuous, fixed armrests
- height adjustable in 8 steps, without tools
- seat height 415–585mm
- only in white with grey seat
- max. user weight 150kg

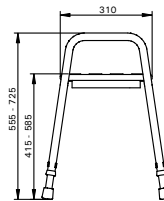
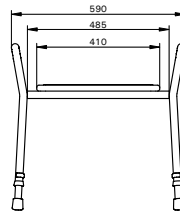

Article nr.	Description
LI2002.0004-02	Shower stool soft seat

Backrest for shower stool LI2002.000

- separate backrest for shower stool LI2002.000, can be fixed without tools
- soft back support
- with integrated handle
- only in white with grey

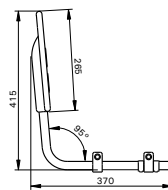
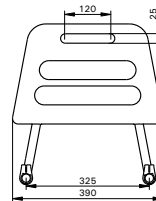

Article nr.	Description
LI2002.0014-02	Backrest for shower stool

Shower stool soft seat extra wide

- soft, removable seat with water permeable slots and extra wide seat
- continuous, fixed armrests
- height adjustable in 8 steps, without tools
- seat height 415–565mm
- only in white with grey seat
- max. user weight 300kg

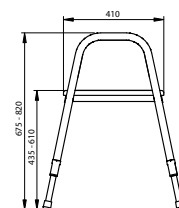
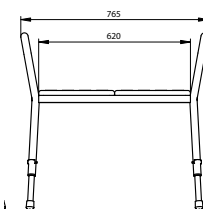

Article nr.	Description
200550313	Shower stool soft seat extra wide

Shower stools

Aluminum shower stool soft seat, standard width

- soft, removable seat with water permeable slots
- continuous, fixed armrests
- seat height adjustable 420mm–620mm
- height adjustable in 8 steps, without tools
- only in white with grey seat
- max. user weight 150kg

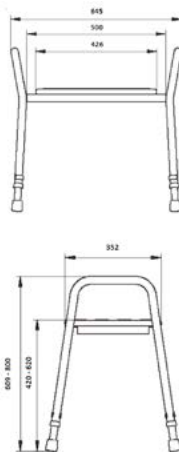

Article nr.	Description
200600112	Shower stool soft seat, standard width, aluminum

Aluminum shower stool soft seat, narrow width

- soft, removable seat with water permeable slots
- continuous, fixed armrests
- seat height adjustable 420mm–620mm
- height adjustable in 8 steps, without tools
- only in white with grey seat
- max. user weight 150kg

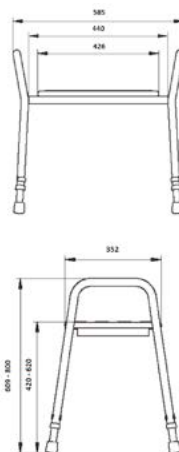

Article nr.	Description
200601112	Shower stool soft seat, narrow width, aluminum

Shower trolleys

Height adjustable shower trolley

- HT-cover* material
- four double braked castors Ø 125mm
- pvc water receiver with flexible hose of 1000mm
- height adjustable via hydraulic pump
- two hinged side fences
- only available in the dimensions as mentioned

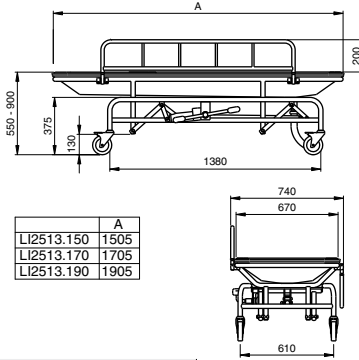

	A
LI2513.150	1505
LI2513.170	1705
LI2513.190	1905



* = Hygiene & Transfer: coated woven polyester textile

Article nr.	Description	
LI2513.1501-02	Height adjustable shower trolley, coated steel white	length 150cm
LI2513.1504-02	Height adjustable shower trolley, coated ss white	length 150cm
LI2513.1701-02	Height adjustable shower trolley, coated steel white	length 170cm
LI2513.1704-02	Height adjustable shower trolley, coated ss white	length 170cm
LI2513.1901-02	Height adjustable shower trolley, coated steel white	length 190cm
LI2513.1904-02	Height adjustable shower trolley, coated ss white	length 190cm

Height adjustable shower trolley

- HT-cover* material
- four double braked castors Ø 125mm
- adjustable backrest by means of a gas spring
- pvc water receiver with flexible hose of 1000mm
- height adjustable via hydraulic pump
- two hinged side fences
- only available in the dimensions as mentioned

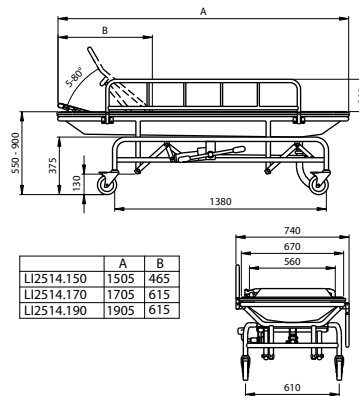

	A	B
LI2514.150	1505	465
LI2514.170	1705	615
LI2514.190	1905	615



* = Hygiene & Transfer: coated woven polyester textile

Article nr.	Description	
LI2514.1501-02	Height adjustable shower trolley, coated steel white	length 150cm
LI2514.1504-02	Height adjustable shower trolley, coated ss white	length 150cm
LI2514.1701-02	Height adjustable shower trolley, coated steel white	length 170cm
LI2514.1704-02	Height adjustable shower trolley, coated ss white	length 170cm
LI2514.1901-02	Height adjustable shower trolley, coated steel white	length 190cm
LI2514.1904-02	Height adjustable shower trolley, coated ss white	length 190cm

Hinged side fence

- suitable for all Linido shower stretchers and shower trolleys
- including plastic mounting clamps

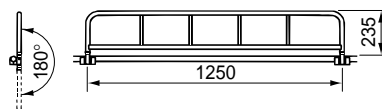

Article nr.	Description	
LI2590.1251-02	Hinged side fence, coated steel white	length 1250mm
LI2590.1254-02	Hinged side fence, coated ss white	length 1250mm

Swimming pool products

Swimming pool hoist chair

- seat and backrest HT-cover* material
- lifting lugs on backrest and forelegs
- independent swivel armrests, ergonomic shape
- armrests in aluminum with white coating
- four stainless steel double braked castors Ø 125mm
- adjustable swing-up footrest
- only available in seat height 490mm
- only available in polished stainless steel 316

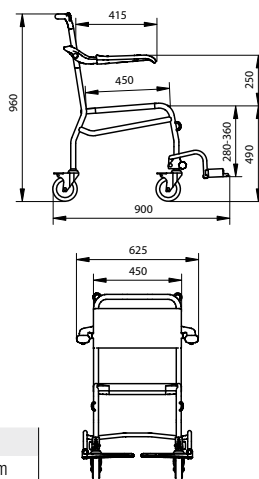

* = Hygiene & Transfer: coated woven polyester textile

Article nr.	Description
LI2141.1087-00	Swimming pool hoist chair, SS 316 polished seat height 490mm

Swimming pool hoist chair (self-propelling)

- seat and backrest HT-cover* material
- lifting lugs on backrest and forelegs
- independent swivel armrests, ergonomic shape
- armrests in aluminum with white coating
- stainless steel double braked castors Ø 125mm and moulded 24" wheels with brake and rim
- adjustable swing-up footrest
- only available in seat height 490mm
- only available in polished stainless steel 316

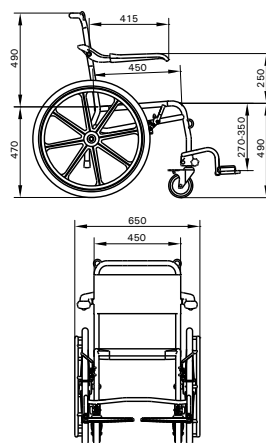

* = Hygiene & Transfer: coated woven polyester textile

Article nr.	Description
LI2142.1087-00	Swimming pool hoist chair (self-propelling), SS 316 polished seat height 490mm

Swimming pool shower trolley

- HT-cover* material
- four stainless steel double braked castors Ø 125mm
- adjustable backrest by means of a gas spring
- height adjustable by means of hydraulic pump with right- and left handed operation
- two hinged side fences
- upper frame can be detached from lower frame and has an inlay frame with lifting lugs
- only available in the mentioned dimensions and length 1900mm
- only available in polished stainless steel 316

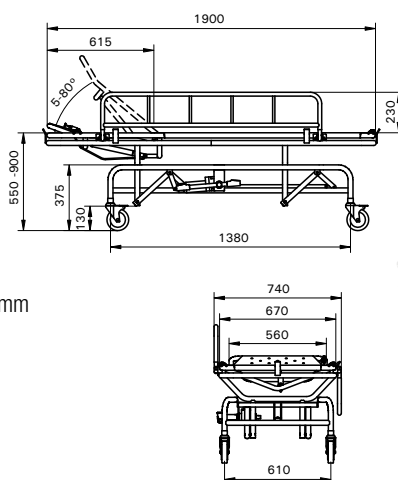

* = Hygiene & Transfer: coated woven polyester textile

Article nr.	Description
LI2514.1987-00	Swimming pool shower trolley, SS 316 polished length 190cm

Our pool products are tailored to the special conditions in pools.

- Stainless steel 316 is resistant to the use of chlorine in the water
- suitable for use on a ramp
- the lifting lugs offer the possibility to lift a user into the swimming pool with a ceiling lift

Combi commode/shower chairs, mobile

Combi shower chair, attendant operated

- stainless steel frame for wet environments and durability
- height adjustable frame
- independent swivel armrests made from soft polyurethane
- detachable seat and backrest, seat with keyhole shaped opening
- 4 maintenance free castors Ø 100mm with double brake
- max. user weight 150kg
- max. user weight Heavy Duty 200kg
- footrests and other accessories can be ordered separately
- 2 year guarantee



201903314

Article nr.	Description
201904314	Combi shower chair, attendant operated, seat height (including toilet seat) 505–630mm
201903314	Combi shower chair, attendant operated, seat height (including toilet seat) 455–545mm
201911314	Combi shower chair, attendant operated, Heavy Duty, seat height (including toilet seat) 505–630mm, extra wide

Combi shower chair, self-propelled

- stainless steel frame for wet environments and durability
- height adjustable frame (via snaplock clips) allows adjustment for different user heights as well as placement of the chair over different toilets heights
- independent swivel armrests made from soft polyurethane
- detachable seat and backrest, seat with keyhole shaped opening
- 2 maintenance free castors Ø 100mm with double brake and 2 self-propelling wheels 24" with hoop
- max. user weight 150kg
- footrests and other accessories can be ordered separately
- 2 year guarantee



201921314

Article nr.	Description
201921314	Combi shower chair, self-propelled, standard
201930314	Combi shower chair, self-propelled, extra wide

Combi tilt commode/shower chair, attendant operated

- Combi tilt, manual operation: gas spring adjustable by a handle
- Combi powered, electrical operation with remote control
- stainless steel frame for wet environments and durability
- height adjustable frame
- independent swivel armrests made from soft polyurethane
- detachable seat and backrest, seat with keyhole shaped opening
- 4 maintenance free castors Ø 125mm with double brake
- max. user weight 150kg
- footrests and other accessories can be ordered separately
- 2 year guarantee



201942314

Article nr.	Description
201941314	Combi tilt commode/shower chair, attendant operated, manual tilt
201942314	Combi tilt commode/shower chair, attendant operated, electrical powered tilt

Combi commode/shower chairs, mobile

Accessories for Combi commode/shower chairs

Article nr.	Description	
201060004	Amputee support	left or right, for all Combi chair models and variants
201030310	Armrest lock	1 pair, for all Combi chair models and variants
853100033	Bucket with lid	round, grey plastic, for all variants of Combi chairs attendant operated and Combi, self-propelled
853100034	Bucket with lid	keyhole shaped, white plastic, for all Combi chair models and variants
200810004	Footrests	1 pair, for all Combi chair models and variants
201040314	Front cross bar	for all Combi chair models and variants with standard width Recommended for use with the Armrest lock accessory
200360004	Headrest	padded polyurethane, for all Combi chair models and variants
200384004	Heel and calf strap	for all Combi chair models and variants
200382004	Hip belt	for all Combi chair models and variants
201070314	Lateral trunk support, right	for all Combi chair models and variants
201072314	Lateral trunk support, left	for all Combi chair models and variants
201061004	Leg support	for Amputee support 201060004, with all Combi chair models and variants
201130314	Soft backrest standard	textile with Velcro, for Combi, attendant operated with standard height and width
201131314	Soft backrest tilt chairs	textile with Velcro, for Combi, tilt with manual or powered tilt
853100604	Transport seat cover	for all Combi chair models and variants



201060004



853100033



853100034



201030310



200810004



201040314



200360004



200384004



201070314



201130314



200382004



201061004



853100604

Technical Specifications

Maintenance

Products used in the bathroom or shower: rinse after use with clean water. For all products: clean with mild, non abrasive cleaners only. Rinse with clean water after use.

Guarantee

Two years warranty on all products, excluding the cushioned cover for shower seat (LI09506.400) and Neoprene parts, which is one year. Linido bathroom solutions conform to the highest standards and comply to the requirements of NEN-EN12182 and to the directive medical devices 93/42/EEG. We are ISO 9001, ISO 13485 and NKH certified.



Material specifications

- steel ST37.2, DIN 17100, Ø 28,6 x 1,5mm
- steel ST37.2, DIN 17100, Ø 25,4 x 1,5mm
- stainless steel AISI 304, Ø 28,0 x 1,5mm
- stainless steel AISI 304, Ø 25,4 x 1,5mm
- stainless steel AISI 316, Ø 25,0 x 1,5mm
- plastic shower seats: glassfibre reinforced nylon
- wall flanges Ergogrip and wall plate hinged arm support: glassfibre reinforced nylon
- plastic bathroom accessories: PMMA
- HT-cover = Hygiene & Transfer, material: special coated woven polyester textile
- wall plates of shower seats: stainless steel AISI 304

Moving and/or hinged parts are always made of stainless steel and/or plastic.

Preparation for coating

Before coating, steel is alkaline de-greased, phosphated and passified.

Coating

Epoxypolyester, 80–100µm thick. Weather-resistant and hardened (International Buchholz hardness test to DIN 53153: > 80). Meets salt spray test to DIN 50021/ASTM B117 (1000 hours, < 1mm).

Isolation sets

Because of the necessary electrical isolation, products for wall mounting or floor mounting, which are not designed with plastic flanges or wall plates, will be delivered with an isolation set including heavy duty washers and caps.

Mounting materials

Linido products will be delivered without any mounting materials, except for bathroom accessories. Determine the type of wall and use suitable fixings. For a durable, reliable mounting, use only corrosion resistant fixing materials.

Weight limits for normal use

Shower seats

user weight: max. 150kg.
user weight for ergonomic shower seat and shower seat with HT-cover material in combination with a Floor support set:
max. 300kg.
load per armrest: max. 75kg.

Fixed and hinged arm supports

user weight: max. 150kg.
lateral pressure: max.100kg.

Grab rails Ergogrip

user weight: max. 150kg.

Swinging support and ceiling support

user weight: max. 150kg.

Shower stool

user weight: max. 150kg.

Shower chairs and commode/shower chairs

user weight: max. 200kg.
load per armrest: max. 100kg.

Mobile commode/shower chair heavy duty

user weight: 300kg.
load per armrest: max. 150kg.

Tilting commode/shower chair and height adjustable-/tilting shower chairs

user weight: max. 150kg.
load per armrest: max. 100kg.

Combi commode/shower chairs

user weight: max. 150kg.
load per armrest: max. 75kg.

All dimensions in this brochure are inmm. Tolerances for all indicated dimensions are ± 5mm.

Direct Healthcare Group reserves the right to modify designs as part of our ongoing product development.



Mounting advice

Product:	Shower seat: LI2202.200-series; Shower seat: LI2203.200-series; Shower seat: LI2203.001-series; Shower seat: LI2223.021-series	Shower seat: LI2201.200-series; Shower seat: LI2221.021-series; Shower seat: LI2201.001-series; Hinged arm support: LI2603.3-series; Fixed arm support: LI2601-series; Floor console: LI2608-series; Swinging support: LI2613-series; Height adjustment system: LI2215-series; Height adjustment system: LI2615-series;	Ergogrip grab rails: LI2611-series 2 flanges; Shower stretcher: LI24-series; Washbasin rail: LI2606-series; Stair newel grab rail: LI2611.011-series; Stair newel grab rail: LI2611.012-series; Door frame grab rail: LI2619-series; Vertical combination grab rail: LI2611.018/019-series 1 flange; Backrest for toilets: LI27-series
Type wall	Mounting with	Mounting with	Mounting with
Solid concrete, Natural stone, Solid red brick, Sand-lime brick	Article number LI2805.0000-00 consisting of: Fischer UX 10 plugs, 7 pieces; lag screw DIN 571, 8 x 90mm SS A2, 4 pieces; lag screw DIN 571, 8 x 70mm SS A2, 3 pieces; washer M8 DIN 125, SS A2, 7 pieces. Always adapt length of fastening material to thickness of load-bearing part of wall construction, taking into account the layer thickness finish.	Article number LI2806.0000-00 consisting of: Fisher UX 10 plugs, 4 pieces; lag screw DIN 571, 8 x 90mm SS A2, 4 pieces; washer M8 DIN 125, SS A2, 4 pieces. For LI2215-series two mounting sets are needed. Always adapt length of fastening material to thickness of load-bearing part of wall construction, taking into account the layer thickness finish.	Article number LI2807.0000-00 consisting of: Fisher UX 8 plugs, 4 pieces; lag screw DIN 571, 6 x 60mm SS A2, 4 pieces; washer M8 DIN 125, SS A2, 4 pieces. For LI2611-series with 3 flanges two mounting sets are needed. Always adapt length of fastening material to thickness of load-bearing part of wall construction, taking into account the layer thickness finish.
Solid/massive aerated concrete (Ytong, Durox), Plaster block, Pumice solid brick Perforated/hollow Hollow brick (Poriso), Hollow sand-lime brick	Injection mortar + injection sleeve and, if necessary: threaded sleeve; threaded rod DIN976 M8, SS A2, 7 pieces; washer DIN125 M8, SS A2, 7 pieces; nut DIN934 M8, SS A2, 7 pieces. Possible materials to apply are: – FIS VS injection mortar; – Fischer threaded rod DIN976 M8, SS A2. Always adapt length of fastening material to thickness of load-bearing part of wall construction, taking into account the layer thickness finish.	Injection mortar + injection sleeve and, if necessary: threaded sleeve; threaded rod DIN976 M8, SS A2, 4 pieces; washer DIN 125 M8, SS A2, 4 pieces; nut DIN 934 M8, SS A2, 4 pieces. For LI2215-series 6 pieces of each are needed. Possible materials to apply are: – FIS VS injection mortar; – Fischer threaded rod DIN976 M8, SS A2. Always adapt length of fastening material to thickness of load-bearing part of wall construction, taking into account the layer thickness finish.	Injection mortar + injection sleeve and, if necessary: threaded sleeve; threaded rod DIN976 M6, SS A2, 4 pieces; washer DIN 125 M6, SS A2, 4 pieces; nut DIN 934, SS A2, 4 pieces. For LI2611-series with 3 flanges 6 pieces of each are needed. Possible materials to apply are: – FIS VS injection mortar; – Fischer threaded rod DIN976 M6, SS A2. Determine length of threaded rod in accordance with mounting set LI2807.0000-00. Always adapt length of fastening material to thickness of load-bearing part of wall construction, taking into account the layer thickness finish.
Plaster board, Squeezed fibreboard, Chipboard	Reinforce the wall with at least 32mm marine plywood, consult producer of partitioning system on the support structure. lag screw DIN 571, 8mm, SS A2, 4 pieces; lag screw DIN 571, 8mm, SS A2, 3 pieces; washer DIN 125 M8, SS A2, 7 pieces.	Reinforce the wall with at least 32mm marine plywood, consult producer of partitioning system on the support structure. lag screw DIN 571, 8mm, SS A2, 4 pieces; washer DIN 125 M8, SS A2, 4 pieces. For LI2215-series 6 pieces of each are needed.	Reinforce the wall with at least 32mm marine plywood, consult producer of partitioning system on the support structure. lag screw DIN 571, 6mm, SS A2, 4 pieces; washer DIN 125 M6, SS A2, 4 pieces. For LI2611-series with 3 flanges 6 pieces of each are needed.
Concealed tank and carriersystem, prepared for armrests.	lag screw DIN 571, 8mm, SS A2, 7 pieces; washer DIN 125 M8, SS A2, 7 pieces.	lag screw DIN 571, 8mm, SS A2, 4 pieces; washer DIN 125 M8, SS A2, 4 pieces. For LI2215-series 6 pieces of each are needed.	lag screw DIN 571, 6mm, SS A2, 4 pieces; washer DIN 125 M6, SS A2, 4 pieces. For LI2611-series with 3 flanges 6 pieces of each are needed.

This advice of mounting methods is a recommendation only. The mounting methods and the length of the screws need to be determined at site according to the type of wall. Always refer to the manual supplied with the product for detailed instructions per product. These manuals can be downloaded from directhealthcare.com Ensure proper maintenance after deployment of the product. Refer to the maintenance instructions for bathroom modifications. These can also be downloaded from handicare.com

Direct Healthcare Group is not responsible for any inexpert mounting of products and the possible damage as a result of that. Direct Healthcare Group is not responsible for modified products. Direct Healthcare Group has compiled this mounting advice with the utmost care.

Ergonomic mounting advice

Guidelines for the installation of products in sanitary facilities

Hinged and fixed arm supports

Hinged arm supports on both sides of toilet ¹	symmetrical support
Protrudes beyond the front of the toilet and the shower seat ²	200mm
Height of arm supports (on both sides) above toilet and/or shower seat ²	min 250mm, max 300mm
Distance between top of arm supports and surface of floor ³	750mm
Distance between inside of arm supports and side wall ²	≥ 350mm
Distance between centre of toilet and/or shower seat and arm supports ¹	350mm
Distance between arm supports ¹	700mm
Walls suitable for installation of sturdy arm supports ¹	
Arm supports can be grasped firmly ¹	
Essential components are sturdy and robust ¹	

Toilets

Distance between centre of toilet and side wall ¹	≥ 550mm
Height of backrest above toilet (measured from toilet seat to bottom of backrest) ³	min 230mm, max 300mm

Shower seats (wall mounted) and commode/shower chairs

Seat height (= top of shower seat from surface of floor) ¹	min value 400mm, average value 470mm, max value 540mm
Distance between centre of shower seat and side wall (corner installations) ¹	550mm
Seat depth ¹	between 400 – 450mm
Total depth of shower seat from rear wall ²	≥ 515mm
Seat area, width x length ¹	700 x 900mm
Free space next to shower seat on both sides, minimum ¹	350 x 1200mm
Free space next to shower seat for sideways transfers and care, minimum 1 side ¹	900 x 1200mm
Free space at front of shower seat ²	≥ 1200 x 1200mm
Standard shower area, preferably sloping towards drainage ¹	900 x 900mm
Support: sturdy armrests, distance above seat ¹	200 – 330mm
Support: distance between armrests approx. ¹	500mm

Grab rails, horizontally installed

Horizontal surface, rail height (above floor or stairs) ¹	between 850 – 900mm
Height of second rail (above floor or stairs) ¹	600mm
Hand must be able to hold onto rail easily, space around rail ¹	≥ 50mm
Hand must be able to move along the rail easily ¹	
Horizontal rail in combination with Click-On frame for shower seat (centre of tube) ³	920mm

Grab rails (and shower rail where appropriate), vertically installed

Distance to side wall ²	≥ 50mm
Reach envelope, height ¹	average value 400 – 1350mm, max value 1800mm
Grab rail as shower rail, length ²	≥ 1000mm
Height of shower head on shower rail from surface of floor ¹	min 950mm, max 2200mm

Grab rails, diagonally installed

Installation at an angle of 45 degrees ³	
Grip point is at the bottom corner, within comfortable reach of the user ¹	average value 400 – 1350mm, max value 1800mm

Definitions:

Minimum value ¹ = minimum value for shorter users

Average value ¹ = average value or preferred value for shared use

Maximum value ¹ = maximum value for taller users

Critical value ¹ = recommended range, limit values

Ergonomic mounting advice

Guidelines for the installation of products in sanitary facilities

Grab rails and other components (shelves, taps, toilet handles etc.)

Walls suitable for installation of sturdy grab rails/arm supports ¹	
Form and function: component can be identified by touch ¹	
Essential components are sturdy, robust and can be grasped firmly ¹	
Distance from an internal angle (in the shower, outside shower spray) ¹	≥ 500–550mm
Height of components (e.g. shower tap) above surface of floor ¹	optimum value 1050mm, average value 900–1200mm critical value 400–1350mm, max value 1800mm
Height of alarm cord, round at wall, above surface of floor ²	400mm
(Grab) rail over full width of door, height from surface of floor ²	900mm

Washbasin adjustment system and washbasin rails

Height for use when sitting, measured from surface of floor to top of tube ¹	min value 620mm, average value 700mm, max value 820mm
To accommodate wheelchair users ¹	820mm

Shower stretchers and trolleys

Height for standing carer, measured from surface of floor to lying surface ¹	min value 800mm, average value 1000mm, max value 1250mm
---	---

Mirrors

Height of mirror from surface of floor, standing ¹	min 1050mm, max 1950mm
Height of mirror from surface of floor, sitting ²	min 600mm, max 1450mm

Space required in bathrooms and toilets

Transfer space

In front of and beside toilets and (area for possible) shower seat ¹	≥ 900 x 1200mm
With assistance, on one side of toilet ¹	≥ 900 x 1800mm
With assistance, on other side of toilet ¹	≥ 900 x 1200mm
With lift ²	≥ 900 x 1200mm
Visitor's toilet in dwelling, free corridor width ¹	≥ 1100mm

Walking space between sanitary items such as toilet, washbasin and shower area ¹ ≥ 900mm

Turning space/turning circle ¹ ≥ 1500 x 1500mm

Standing space for wheelchair, (partially) under washbasin ^{1,2} ≥ 900 x 1200mm

Sitting space

Distance from backrest ²	≥ 850mm
Sitting space, including backrest, width x length ^{1,2}	≥ 700 x 900mm
Sitting space, wheelchair user, width x length ²	≥ 900 x 1200mm
Leg room , height x width x depth ¹	≥ 600 x ≥ 600 x 600mm
Foot space , height x depth ¹	≥ 200 x ≥ 800mm

Definitions:

Minimum value ¹ = minimum value for shorter users

Average value ¹ = average value or preferred value for shared use

Maximum value ¹ = maximum value for taller users

Critical value ¹ = recommended range, limit values

Sources:

- Handboek voor Toegankelijkheid, Over de ergonomie van buitenruimten, gebouwen en woningen (Accessibility Manual, The ergonomics of outdoor spaces, buildings and dwellings), M Wijk 7th Edition, ISBN 978-90-12-58505-7.
- Handboek voor Toegankelijkheid, Over de ergonomie van buitenruimten, gebouwen en woningen (Accessibility Manual, The ergonomics of outdoor spaces, buildings and dwellings), M Wijk 6th Edition, ISBN 978-90-6228-685-0.
- Direct Healthcare Group, your professional partner for functional, durable sanitary products.

NOTE: This mounting advice is based on the Dutch laws, regulations and recommendations. For other countries other information can apply.

Accessible, safe and great looking bathrooms

Direct Healthcare Group's own product series for assistive devices designed to provide ergonomic support, comfort and increased independence for the user in various bathing, showering and toileting situations, whilst also providing for the convenience and safety of the caregiver. Whether you live independently, live or work in an institution or have a minor or major physical disability; for all people with their own demands and wishes, Direct Healthcare Group offers a wide range of safe, practical, durable and ergonomic aids with modern design; products and accessories creating accessible, safe and, in addition, great looking bathrooms. Our bathroom aids are equally suitable and functional in all environments, from smaller private homes to public environments and major hospitals. With Direct Healthcare Group, everyone can experience the comfort of safety every day.

Designed and produced by Direct Healthcare Group

With 80 years of experience, Linido is a specialist in the bathroom safety field, producing assistive devices you can trust.

Direct Healthcare Group offers solutions and support to increase the independence of disabled or elderly people as well as to improve the convenience of those who are caring for them.

The Direct Healthcare Group is one of the leading healthcare companies in Europe with own manufacturing organisations and sales companies in Great Britain, Norway, Sweden, Denmark, Germany, the Netherlands and France. Direct Healthcare Group's products are also distributed by partners in more than 40 countries worldwide.

Our wide range of high quality products includes:

- **System RoMedic** – a complete, easy transfer system
- **Kirton** – specialist seating
- **Nightingale** – 24/7/365 rental & service solutions
- **Direct Healthcare Services** – Intelligent pressure area care mattresses & cushions
- **Qbitus Products** – Wheelchair seating solutions (bespoke pressure relieving cushions)