



Moving Health Forward

# Raizer<sup>®</sup> II

User Manual





# Raizer® II

The Raizer is a battery-powered mobile lifting chair which helps a lying person up to an almost standing position in a few minutes.

The Raizer can be operated by only a single assistant and requires minimal physical effort from the assistant aside from a helping hand.

The Raizer is simple to operate by means of the control panel mounted on the side of the seat, or with the remote control.

## Contents

1. Indications/Contraindications for Use .....	04
2. Technical Specifications .....	07
3. Safety Instructions .....	10
4. Functionality .....	11
5. Prior to Use .....	11
6. Operation .....	12
7. Disassembly .....	16
8. Charging the Raizer .....	16
9. Fault Finding .....	16
10. Maintenance .....	18
11. Service Inspections .....	20
12. Spare Parts & Accessories .....	20
13. Troubleshooting .....	23
14. Electrical Diagram .....	23
15. Disposal .....	24

# 1. Indications/Contraindications for Use

## 1.1 Indications of Use

The Raizer is a battery-powered mobile lifting chair which helps a lying person up to an almost standing position in a few minutes. The Raizer can be operated by only a single assistant and requires minimal physical effort from the assistant aside from a helping hand. The Raizer is simple to operate by means of the control panel mounted on the side of the seat, or with the remote control. The Raizer should only be used to bring a person lying on the floor to a seated or almost standing position, if the person is unable to do so by him-/herself. The person may require relocation from this position. A hygiene cover or a form of textile must be applied to the seat if the person to be lifted is NOT wearing clothes on areas in direct contact with the Raizer.

## 1.2 Patient Population

The intended client population are individuals with limited physical mobility who could benefit from the device. The Raizer models are suitable for use by clients of varying ages who weigh less than 150 kg. The Raizer is not suitable for people who may have suffered an injury during a fall and/or where the injury cannot be detected (for instance where there is no system available to check for injuries, the patient cannot provide feedback on their condition, or they have a limited ability to provide feedback).

## 1.3 Intended User Population

The intended user populations of the Raizer aids are experienced healthcare professionals, clinically trained to move clients safely and caregivers that do not necessarily have professional training. The patient themselves could also be a potential user (to operate only)

Medical professionals – Hospital and District Nurses, Health Assistants, Paramedics/Emergency Ambulance Responders, Nurse Practitioners and Doctors. Any other medically trained staff who may need to lift a fallen patient to a sitting or near standing position.

## 1.4 Contraindications

The Raizer lifting chairs cannot be used for patients who:

- Have suffered an injury during a fall or/and where the injury cannot be detected.
- Are not fully conscious during the lifting process and able to provide feedback.
- Have an injury that could be increased by using the chair may increase the injury.
- Weigh more than 150 kg.

The Raizer should not be used for patients with unstable fractures or an intolerance to motion.

## 1.5 Symbols



CE marking: The product complies with the Medical Device Regulation (EU) 20174/745



Consulting the manual is mandatory



This product is a medical device



Warning triangle indicates when special attention is necessary



Legal Manufacturer



This product is a Class II equipment (IEC 61140)



Date of Manufacture



The product is a type BF equipment according to EN 60601-1



Serial number



Max. user weight



Item No. / Catalogue Number: 7 digits



Electronic scrap. When disposing of the products, sub-components should be recycled



Unique Device Identification



EC Representative



Temperature limitations

**IP52**

Ingress protection  
 5 = Protected against dust limited ingress, not harmful deposits  
 2 = Protected against direct sprays of water up to 15° from the vertical



Humidity limitations



Do not submerge



Atmospheric pressure limitations



Do not use this device in the bath, shower or water filled reservoir



Keep dry (when stored)

## 1.6 Warnings and Cautions



- Read the user manual thoroughly before using the lifting chair
- The max. load of the Raizer is stated on the CE mark on the rear of the seat. The Raizer can be used approx. 40 times at full load on a full charge. A charger is included with your Raizer.
- Movable parts: Be careful not to get crushed. Service inspections must always be undertaken by a qualified service technician.
- The owner of the device is obliged to maintain it according to the maintenance guide in section 9. It is strictly forbidden to modify the product as this may endanger people's personal safety.
- The Raizer's parts may be hot or cold to touch in case they have been stored in the baggage compartment of a car or in direct sunlight. Please consider this before using the device.
- Lifting capacity: Max. 150 kg (330.7 lbs).
- Do not push or transport the lifting chair while the person is sitting in it. The Raizer is not designed for transport of persons.
- Do not stand on the lifting chair. The Raizer is not designed for transport of persons.
- Never flush the lifting chair with water and never immerse it in water. General cleaning may only be done using a well-wrung cloth or sponge.
- Do not dispose of batteries, electrical or electronic equipment with unsorted household rubbish. When disposing of this device, ensure compliance with local ordinances and regulations.
- Battery only to be replaced by trained personnel.
- Check the mains power cord is free from damage and is positioned so as not to cause an obstruction, or injury, e.g. strangulation.
- Do not use in the presence of flammable anesthetics.
- Servicing to be conducted by qualified service personnel only.
- When servicing use only identical parts.
- The medical professional is responsible for applying his/her best medical judgment when using this system.
- Do not use in an oxygen enriched environment.
- No part of the medical device should be serviced while it is in use.
- Not suitable for sterilisation.

- Do not use abrasive cleaners, phenol disinfectants, solvents or alcohol-based cleansers, e.g. Dettol, Phenicol, Hibiscrub, Clearsol, Stericol, Hycoline,
- Wireless equipment such as mobile phones should be kept at least 1 foot away or 0.3 metres away from this equipment.
- If the device is to be used by a lay operator or responsible organisation, contact the manufacturer or representative for assistance if needed, in setting up, using or maintaining the ME EQUIPMENT or ME SYSTEM
- Electric shock hazard; do not remove back of power unit.
- The materials used in the manufacture of all components of the system comply with the required fire safety regulations.
- No modification of this equipment is allowed. Do not use unspecified parts.
- Intended for home healthcare and professional healthcare facility environments.
- Types of ambulance the device is intended: road-going vans, boats, helicopters, fixed-wing aircraft.
- Do not connect to any other medical device or equipment.
- Care should be taken that the device operation is not adversely affected ie, by pets, pests or children.
- The power unit / power adapter should be cleaned between patient use as a minimum.
- Do not place the unit or power adapter on or near a heat source.
- The above warnings, cautions and any safety considerations should be observed on a routine and regular basis, not only upon installation.

## 1.7 Cleaning

The Raizer and charger adapter can be wiped down with detergent or disinfectant solution or wipe\*. Do not use solvents.

Unsuitable for sterilisation.

Dispose of the power unit / power adapter in accordance with the local regulations including WEEE requirements.

## 2. Technical Specifications

### 2.1 Dimensional Drawings

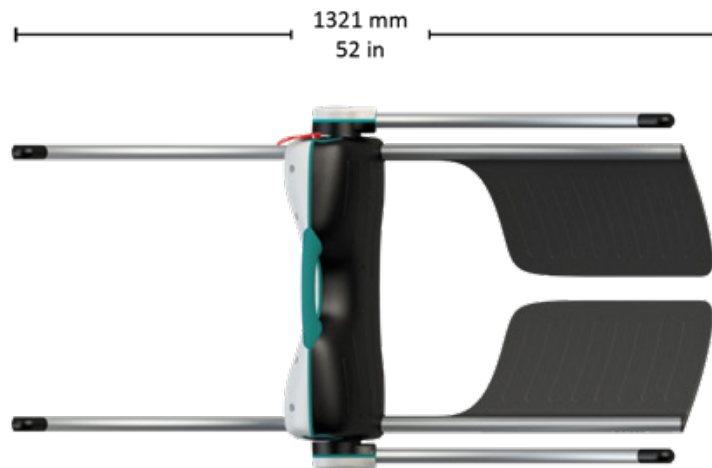
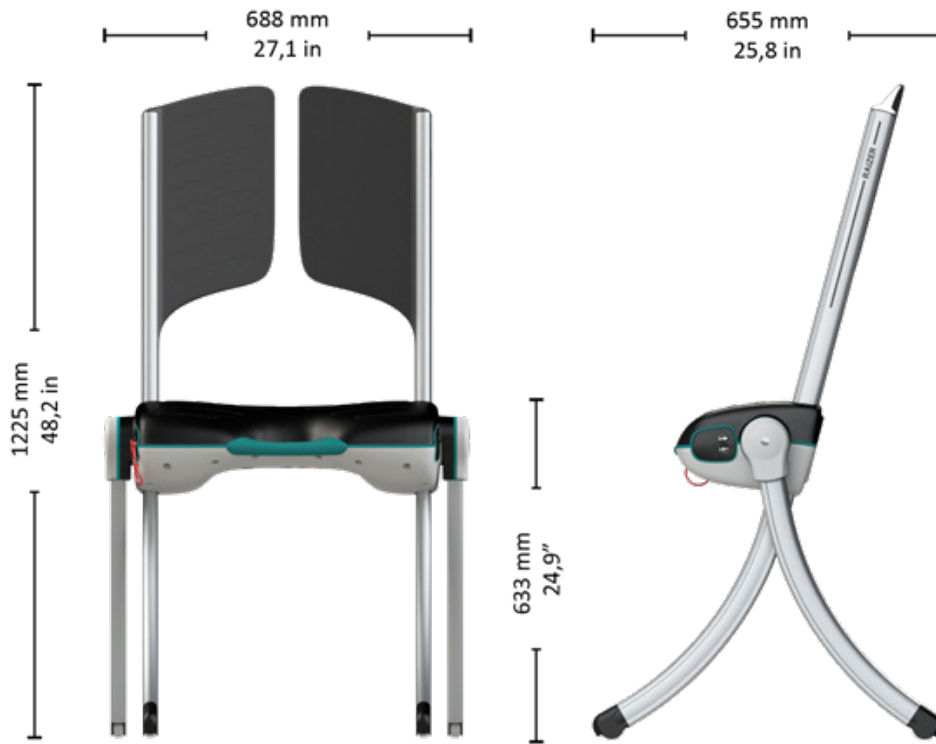

## 2.2 System Specifications

Battery:	LiFePO <sub>4</sub> , 12V, 5AH
Number of lifts on full charge:	40 with a max. load. Approx. 80 with an average load
Duty cycle:	1 min. / 5 min.
Charging time:	Up to 6 hours with the provided charger
Charging of depleted battery:	10-15 min. = 1 lift
Dimensions (L x W x H):	Standing - 655mm x 688mm x 1225mm Lying - 1321mm x 688mm x 277mm
Weight:	Motor unit/seat - 9.2kg Backrest and legs - 4.9kg Total weight - 14.1kg
Lifting capacity:	Max. 150 kg / 330.7 lbs
Lifting time:	20-30 sec.
Noise level:	<70dB(A)
Dust and water:	IP52
Operating forces of controls:	<3N (300g)
Expected service life:	>5 years
Working temperature:	+5°C to +40°C
Storage temperature:	-25°C to +70°C

The time required for the device to warm from the minimum storage temperature until it is ready for its intended use when the ambient temperature is 20°C is 1 hour.

The time required for the Raizer to warm from the minimum storage temperature for its intended use and between uses when the ambient temperature is 20°C; and the time required for the Raizer to cool from the maximum storage temperature between uses until the Raizer is ready for its intended use when the ambient temperature is 20°C is 1 hour.

Materials:	Motor unit/seat - Polycarbonate and ABS Backrests - Polycarbonate and ABS Legs - Aluminium
------------	--

The Raizer meets the relevant requirements, notably the following standards:

EN/ISO 10535:2007	Hoists for the transfer for disabled persons
EN 12182:2012	Assistive products for persons with disability - General requirements and test methods
EN 60601-1:2006+Corr-1,-2:2008 +AC, A1:2013	Medical electrical equipment - Part 1
EN 60601-1-11:2015	Requirements for medical electrical equipment and medical electrical systems used in the home healthcare environment

## 2.3 Specifications USB Charger

USB Type A	Min. 5Volt 1 Ampere
------------	---------------------

## 2.4 Specifications Charger

Type 2241 4-cell LiFePO<sub>4</sub> Charger

Input voltage:	100-240V nom. Min. Max. 90-264 VAC
----------------	------------------------------------



Power:	Max 15W
Output voltage:	14.6V
Dimensions (L x W x H):	120mm x 47mm x 70mm
Weight:	170g
Working temperature:	+5°C to +40°C
Storage temperature:	-25°C to +70°C
Dust and water:	IP4X
Expected service life:	>5 years

## 2.5 Specifications Radio Components

All radio components comply with the following standards:

EU2014/53/EU	Radio Equipment Directive (RED)
FCC (USA)	CFR 47 Part 15
ISED (Industry Canada)	RSS-210
EN 62479:2010	Assessment of the compliance of low power electronic and electrical equipment with the basic restrictions related to human exposure to electromagnetic fields (10 MHz to 300 GHz)
EN 300 440, v2.1.1	Electromagnetic compatibility + Radio spectrum Matters
BS EN 60601-1-2:2015	Medical electrical equipment - Part 1-2: Electromagnetic disturbances
CISPR 11, Class B	Emission
BS EN 61000-4-2:2009	EMC - Testing and measurement techniques. Electrostatic discharge immunity test
EN 61000-4-3:2006+ A1:2008+IS1:2009+ A2:2010	EMC - Radiated, RF, electromagnetic field immunity test
EN 61000-4-8:2010	EMC - Power frequency magnetic field immunity test
AS/NZS 4268	Radio Equipment and Systems –Short Range devices
AS/NZS 2772.2	Radio Frequency Fields (mean power < 1 mW)

### MODULE1:

2,4GHz Short Range device	Receiver Class 3; FCC ID:2A8IL-MODULE1
Dimensions (L x W x H):	72mm x 33mm x 10mm
Weight:	10 g (0,035 lbs.)
Frequencies:	2.410GHz 2.435GHz and 2.460GHz
Duty cycle:	< 1%(only TX for pairing Remotes)
Power:	< 0.6mW Controlled environment
Supply:	5.6 Volt 30mA
Dust and water:	IP 52 (protected from limited dust ingress; protected from water spray)
Working temperature:	+5°C to+40°C
Storage temperature:	-25°C to +70°C
Expected service life:	>5 years

### Handheld REMOTE1:

2,4GHz Short Range device	Receiver Class 3; FCC ID:2A8IL-REMOTE1
Dimensions (L x W x H):	80mm x 60mm x 21mm
Weight:	47 g (0.10 lbs.)
Frequencies:	2.410GHz 2.435GHz and 2.460GHz
Duty cycle:	<1%
Power:	<0.6mW Controlled environment, Hold to run
Battery:	3 Volt CR2032
Dust and water:	IP 42
Operating forces of controls	< 3N (300g)
Working temperature:	+5°C to +40°C / 41°F to 104°F
Storage temperature:	-25°C to +70°C / 13°F to 158°F
Expected service life:	>5 years

### 3. Safety Instructions

#### 3.1 Avoid Personal Injury



Even though the Raizer comes fitted with various safety features, never use it if persons or animals unintendedly are close by, as this may lead to the risk of crushing. Never allow children to play with the Raizer.

#### 3.2 Personal safety

- To avoid personal injury, it is NOT permitted to use the lifting chair when someone or something is at risk of being injured by crushing, cutting, falling, slipping, or similar.
- It is important that the assistant ensures that the chair can move without putting anyone or anything at risk.
- Be extra careful when there are children and physically or mentally challenged people on or near the chair, as these groups cannot always be expected to be able to foresee the possible consequences of its movements.
- Never load more on the chair than the 150 kg (330.7 lbs) stated on the loading sign as the maximum load.
- Our recommendation is to never use the lifting chair if the person is not secured with the seat-fitted safety belt.

#### 6.4 Safety belt

- The Raizer is fitted with a lap belt when delivered. The lap belt will offer safety and security and help keep the person in position during the lift. Several safety belts can be ordered as spares.
- However, it is important to note that the lap belt will not support the torso, so additional arrangements should be used if necessary.

#### 6.5 Handling

The Raizer will normally be supplied by your dealer. The lifting chair is ready for use upon delivery. The Raizer can be transported in the 2 provided bags. One is a protective cover for the seat itself. The seat is carried in the turquoise handle.

The backrest and legs are carried in the bag by using carrying straps for hand or back (long strap for shoulders or two straps as a backpack).

Do not subject the Raizer to severe knocks or blows as this can affect product functionality.



Keep the accompanying remote control dry and do not subject it to severe blows, such as by throwing it or dropping it, etc. Cleaning may only be done using a well-wrung cloth.

 Never use a high-pressure jet or running water to rinse the chair and never immerse it in water, as this can damage the product.

## 4. Functionality

The Raizer is a battery-powered mobile lifting chair which raises a fallen person up to an almost standing position in a few minutes. It can be operated by only a single assistant and requires no physical effort from the assistant aside from a helping hand.

The lifting chair works by the assistant assembling the Raizer around the fallen person and is operated by using the control panel on the seat or by means of the remote control. The assistant can raise the fallen person to a sitting or almost standing position ready for relocation.

To use the Raizer, hold down the button for the entire lift. The lifting will stop if the button is released.

## 5. Prior to Use

 Make sure that the Raizer is always fully charged. A charger and an adapter cable for USB charging are supplied with the device, and we recommend that the Raizer always be charged and ready for use. You should check the Raizer for power at least once every 6 months and recharge if necessary. See also section 8.

### 5.1 Charging the Raizer

The Raizer must be charged for at least 6 hours prior to its first-time use, as required and as a minimum every 6 months with the provided charger).

It is advisable to check the battery indicator on the side of the lifting chair to verify the level of the charger.

Charging may also be done using the USB cable; however, this takes considerably longer than with the charger (approx. 20 hours for a full charge).

Check that the chair is charged prior to use. The battery indicator must not flash red.

The Raizer can be stored anywhere you like. However, lifting speed will be reduced if the battery temperature falls below 0°C. In practice, though, if charged, the Raizer will always be able to perform its task, even if stored in a vehicle in a severe frost (-15°C). However, you must bear in mind that components which are either very hot or cold, may be uncomfortable to touch.

### 5.2 Operating the Raizer

The control panel is situated on the right side of the seat.

To turn on the Raizer, press the on/off button or the UP/DOWN arrow keys on the side of the chair. Check that the chair is charged prior to use. The battery indicator must not flash red.

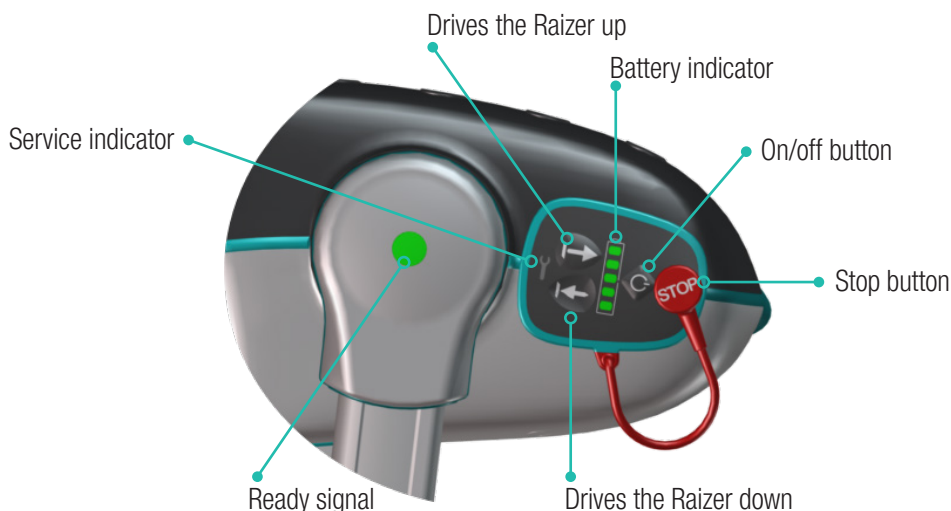

## The Remote Control

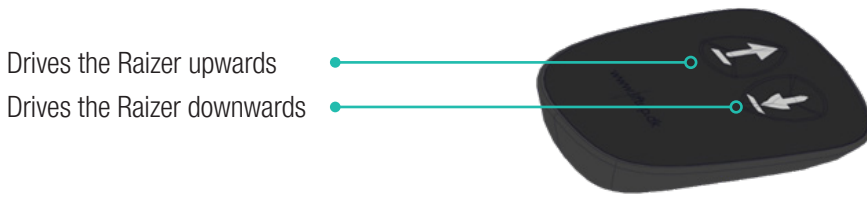

The remote control is placed in a pocket on the side of the seat and fixed with a magnet. It is released with a light push to the upper part of the remote control.

BE CAREFUL not to lose the remote control when releasing it from the Raizer.

1. Press the UP arrow to drive the lifting chair upwards.
2. The Raizer will only run for as long as the button is activated.

### NOTE:

The Raizer must be turned on for the remote control to work (by a light push of the on/off button on the side of the chair).

1. The stop button is activated when it is required to stop any movement of the Raizer. Pull the button or the cord to release the button from its position. The Raizer can only be reactivated when the stop button has been remounted.

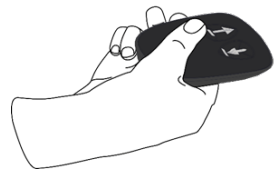
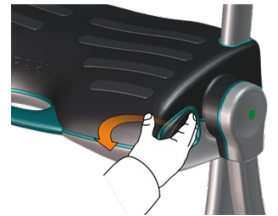

## 6. Operation

### 6.1 Assembling the Raizer



#### IMPORTANT!

Please observe that the backrest should be attached at first. If the legs are attached at first, it will disturb the fitting of the backrest. Fit one side at a time.

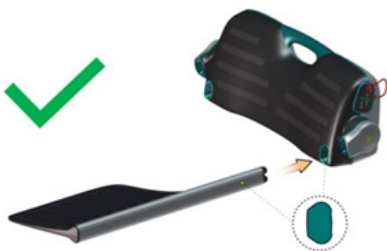

*Correct assembly  
(first mount the backrest)*



*Incorrect assembly  
(do not mount the legs first)*

### 6.2 Placing the Raizer

1. Arrival and approach.  
You may place a pillow under the person's head for better comfort.
2. Place the seat on the floor next to the lying person. The person must lie on the back. Lift the thighs to an angle. Carefully push the seat under the thighs.

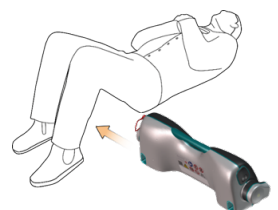
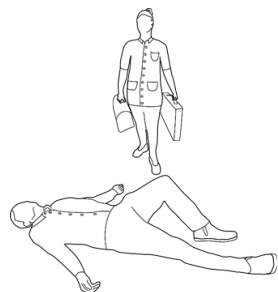

**NOTE!**

Always attach the backrest at first. If the legs are attached at first, it will disturb the fitting of the backrest.

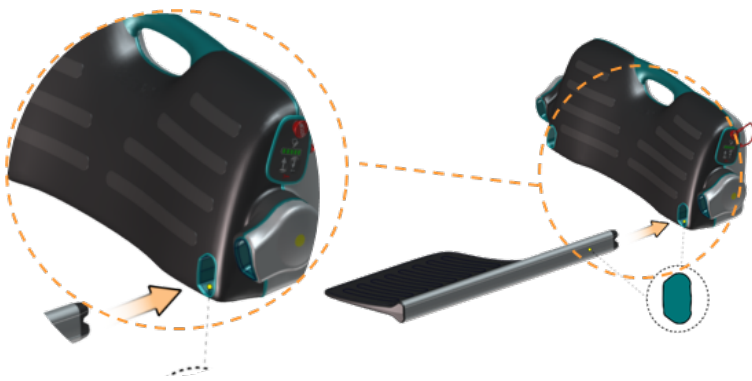

*Take care that the backrest is attached into the correct hole*

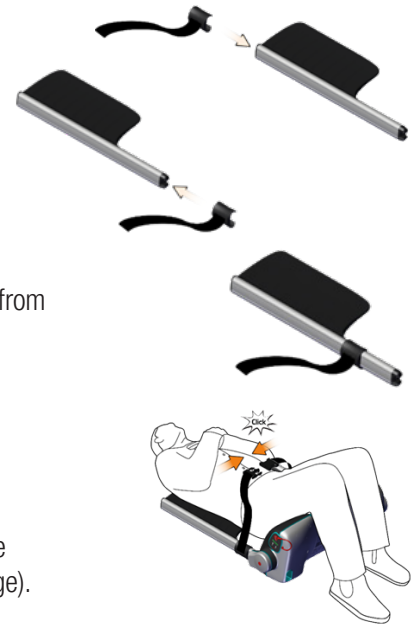

**6.3 Mounting the Seat Belt**

1. If the seat belt has not already been fitted on the backrest, mount it by pushing the fitting downwards over the backrest profile with a sliding movement. The fitting can be mounted from both ends (see illustrations).
2. Fasten the seat belt. A distinct click will be heard.



3. **WARNING!** Never lead the seat belt under the rear legs of the Raizer, as this may cause the person to be crushed. (The seat belt clip however will break off before any personal damage).



**6.4 Mounting the Backrests**

**Left backrest**

1. Lift the person carefully by the shoulder, with a light push to the elbow. Push the backrest carefully under the shoulder of the person.
2. Click the backrest into place in the seat with a sliding movement. If necessary, place your foot in front of the seat to stop it from slipping forward. A confirmation tone will sound, when the backrest has been correctly fitted.

**Right backrest**

1. Lift the person carefully by the shoulder, with a light push to the elbow. Push the backrest carefully under the shoulder of the person.
2. Click the backrest into place in the seat with a sliding movement. If necessary, place your foot in front of the seat to stop it from slipping forward. A confirmation tone will sound, when the backrest has been correctly fitted.

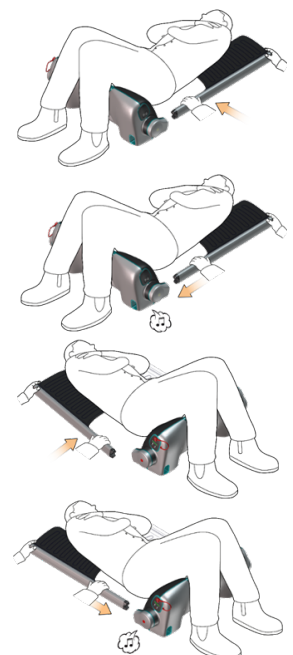

## 6.5 Mounting the Legs

NOTE! All 4 legs are identical and may be fitted in any sequence.

### Left rear leg

Insert the leg carefully, until it clicks into place. A confirmation tone will sound when the leg has been correctly fitted.

### Left front leg

Insert the leg carefully, until it clicks into place. A confirmation tone will sound when the leg has been correctly fitted.

### Right rear leg

Insert the leg carefully, until it clicks into place. A confirmation tone will sound when the leg has been correctly fitted.

### Right front leg

Insert the leg carefully, until it clicks into place. A double confirmation tone will sound when the last leg has been correctly fitted.

### Ready signal

When all 4 legs have been fitted correctly, a double confirmation tone will follow.

The double alert signifies that the Raizer is ready to lift a person.

The LED light on the side of the Raizer now changes from yellow to green to demonstrate that the Raizer is ready for operation.

## 6.6 Headrest

We recommend supporting the neck and head of the person to be lifted as it may be hard to keep the head upright during the lift. In most cases, in connection with the Raizer II lifting chair, we recommend that the helper supports the person's neck with one hand during the lifting process while simultaneously operating the remote control with the other hand.

However, in cases where it is necessary or practical for the helper to have both hands free, a headrest (accessory) may be a great help.

To apply the headrest, push it under the neck of the lying person so that it slides between the two backrests.

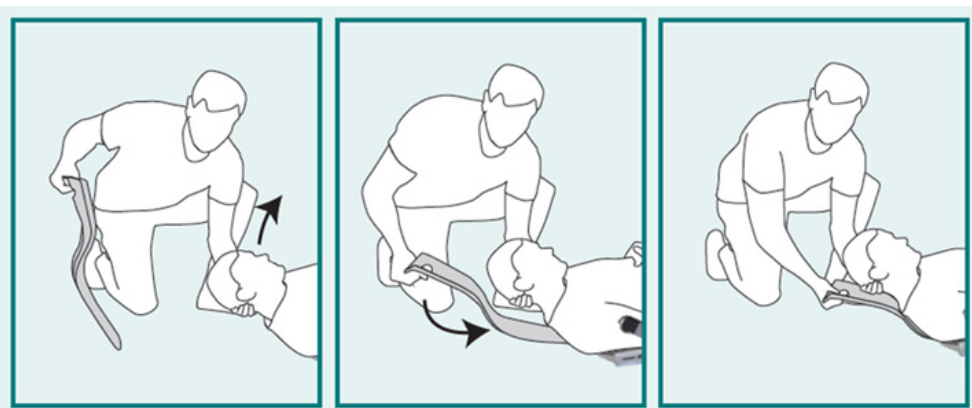
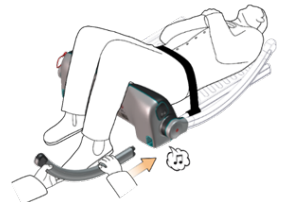

## 6.7 Alerts Prior to Lifting a Person

### Positioning the person

Make sure that the shoulders of the person are placed suitably on the Raizer and that the arms are crossed over the chest, as the rear legs will move downwards towards the floor as soon as the UP arrow is pressed and may hit the person should shoulder/arms be in the way.

### Rear legs

Please watch out for a potential crushing between the rear legs and the floor. Make sure to keep hands and feet at a safe distance from the movement of the legs.

### Front legs

Take care that the person's legs are together and that feet/legs are not at risk of getting in under a front leg when the chair is raised, as the front legs move toward the floor before the chair begins to lift the person.

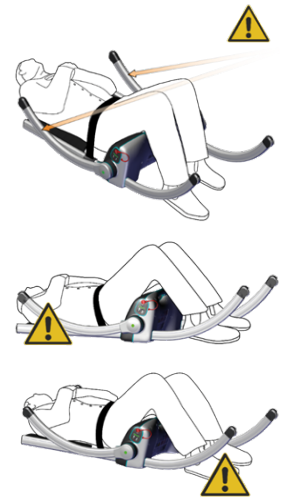

DO NOT run the chair up before you have made sure that the person's feet, arms, hands and other extremities will not be endangered by the movements of the lifting chair.

## 6.8 Lifting a Person

1. The Raizer is operated by using the control panel on the seat or by means of the remote control.
2. The remote control is placed in a pocket on the side of the seat and fixed with a magnet. It is released with a light push to the upper part of the remote control. BE CAREFUL not to lose the remote control when releasing it from the Raizer
3. The Raizer is now ready to lift the person. Before initiating the lift, make sure that the person is ready, and give a warning that the lift will begin.
4. Support the neck of the person with one hand or apply a headrest (accessory). Press the "UP arrow" on the side panel or the remote control.
5. Press the UP arrow until the person has reached the requested position.
6. The Raizer will automatically stop when reaching its top position and the person is in an upright sitting position.

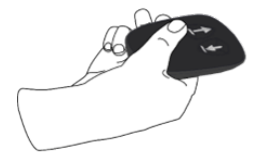
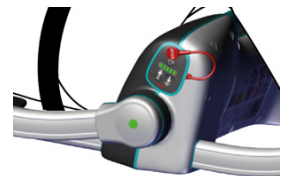

### NOTE:

The Raizer is safeguarded against running too high and therefore stops automatically in its top position. A confirmation tone will sound, indicating that the Raizer has reached its top position.



NEVER push the Raizer when a person is sitting on it. The wheels of the legs are only meant to avoid scratches to the floor in connection with the lifting procedure. The Raizer is not designed for transport of persons.

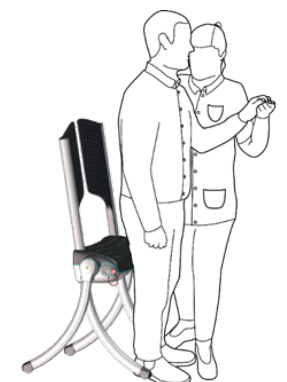
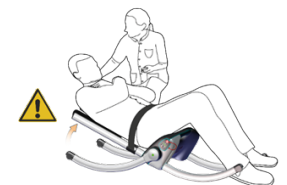

## 7. Disassembly



**IMPORTANT!** Always run the Raizer to the horizontal position prior to disassembly (otherwise the next assembly of the Raizer will be upset).

When the Raizer has been run into the horizontal position and is ready for disassembly, place the remote control in its pocket at the side of the seat. If all legs are dismantled and the remote control has not been put back into its pocket, the Raizer will begin to 'call out' for the remote control with a warning tone (a vibrant tone). As soon as the remote control is in place, the warning tone will cease.

Always run the Raizer to the horizontal position (until it stops with a distinct sound), prior to disassembly (otherwise the next assembly of the Raizer will be upset).

The Raizer is disassembled by pulling all legs (4) and backrests (2) out.

Do not forget to place the remote control in its pocket, as otherwise a vibrant warning tone will sound when all legs have been dismantled.

When the Raizer has been disassembled, all parts are stowed away in the transport bag.



## 8. Charging the Raizer

The battery indicator (LED) lights green when the battery is fully charged.

The battery indicator (LED) flashes red to show that the battery capacity is below 10% and the Raizer must be recharged.

### NOTE:

The indicator only lights up when the lifting chair is turned on.

The charger socket is situated in the same place as the red stop button.

1. Remove the stop button and plug the charger cable into the socket. The plug is mounted with a magnet and will snap into place by itself.
2. Connect the provided charger to the socket on the Raizer. Or use the provided USB cable.

**NOTE:** Charging with the USB cable takes considerably longer than with the charger.



The Raizer must be charged for at least 6 hours prior to its first-time use, as required and as a minimum every 6 months (with the provided charger). Approx. 10-15 minutes' charging is sufficient for 1 lift. A full charge gives approx. 40 lifts at room temperature. The number of lifts will be reduced at lower temperatures.

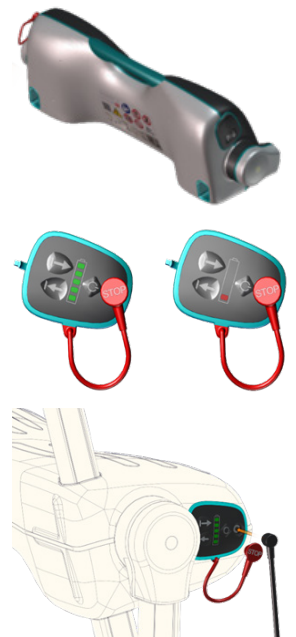

## 9. Fault Finding

Troubleshooting		
Issue	Cause	Solution
The Raizer II does not run, even if the up/down arrows are pressed.	The stop button is activated. 2-tone alarm.	Replace/reposition the magnetic stop button. Check that the ready-for-service LED is lit green.
	The rear legs are not correctly fitted. Double-tone alarm.	Fit the rear legs so that the confirmation sound is heard. Check that the ready-for-service LED is lit green.
	The front legs are not correctly fitted. Double-tone alarm.	Fit the front legs so that the confirmation sound is heard. Check that the ready-for-service LED is lit green.
	The backrests are not correctly fitted. Double-tone alarm.	Fit the backrests so that the confirmation sound is heard. Check that the ready-for-service LED is lit green.
	The battery is depleted. See LED	Charge the Raizer II with the supplied charger only.



The Raizer II stops running at the top stop, even if the up arrow remains pressed.	The chair has reached the top stop. Pleasant single tone.	Completely normal. The Raizer II has reached its maximum height.
The Raizer II stops running up before the top stop, even if the up arrow remains pressed	The Raizer II is overloaded. 2-tone reject alarm.	Lower the Raizer II and return the patient to the ground. Try to reduce the load if possible.
	The battery is depleted. See LED	Lower the Raizer II and return the patient to the ground. Charge the Raizer II with the supplied charger only.
Remote control* does not work.	The Raizer II is not powered on/activated.	Briefly press the up or down buttons on the side of the device. Check that the ready-for-service LED is lit green.
	The remote control* battery needs replacing.	See section 10.5
	The remote control* is not correctly paired with the Raizer II.	See section 10.4

## 10. Maintenance

### 10.1 Cleaning

**IMPORTANT:** General cleaning may only be done using a well-wrung cloth or sponge.

The Raizer is **NOT** waterproof and therefore must not be immersed in water or flushed with running water. It is however acceptable to clean the Raizer with a damp cloth.



The Raizer must **NOT** be flushed with water



The Raizer must **NOT** be immersed in water

You can disinfect your Raizer by using the below disinfectants recommended:

Hydrogen Peroxide Aq.: 1,0% (max.) (diluted hydrogen peroxide)

Ethanol based products: 70-85 v/v%. alcohol

Soap solutions: PH value max. 9



**NEVER** use a high-pressure cleaner or other power flushing or running water, as this may cause permanent damage to the lifting chair.

### 10.2 Mechanical Maintenance

The mechanical maintenance of the Raizer shall normally only be undertaken in connection with the regular annual service inspection. This is to be undertaken by a qualified service technician in accordance with section 10.

Should unexpected errors or unusual sounds occur, contact DHG.

### 10.3 Maintenance of the Transport Bags

The provided transport bags may be cleaned with a well-wrung cloth or in the washing machine at max. 30°C. You can disinfect the bags by using alcohol-based disinfectants at a concentration of 70–85 v/v%.



Wash at max. 30°C



No tumble drying



No ironing



No bleach

### 10.4 Pairing the Transmitter and the Receiver (Remote Control)

1. The Raizer battery must be fully charged, see section 8.

2. The Raizer must be switched off either using the on/off button or await the Raizer switching off automatically after 10 minutes without activity.
3. Press the UP and DOWN arrows of the remote control at the same time and keep them pressed for approx. 5 seconds until the control LED on the remote control begins to flash slowly. The remote control is now in installation mode for 2 minutes.
4. Within these 2 minutes, switch on the lifting chair you require paired/associated with the remote control by pressing the UP/DOWN arrows on the side of the chair simultaneously.
5. The control LED on the remote control is paired/associated with the lifting chair when it stops flashing.
6. Test the system to make sure that the pairing has been performed correctly; if not, repeat steps 1-5 above.



**Resetting the transmitter and the receiver:**

To reset a remote control so that it is no longer paired/associated with the Raizer, do the following:

1. Press the UP and DOWN arrows at the same time and keep them pressed down for approx. 5 seconds until the control LED begins to flash slowly. The remote control is now in installation mode for 2 minutes.

2. Within the 2 minutes, perform the following sequence:

Press: UP, UP, DOWN, DOWN, UP, DOWN, UP, DOWN

When the control LED starts to flash quickly, the remote control is no longer associated/paired with the Raizer.

**Alternatively:**

If the remote control is open, you may push “reset” to restore the initial state.

**10.5 The Remote Control**

A CR2032 battery is installed in the remote control.

 In order to ensure reliable function, swap the battery every 2 years

 Be careful not to swallow the coin cell

 Keep batteries out of reach of small children. Should a child swallow a battery, consult a physician immediately

 Do not dispose of batteries, electrical or electronic equipment with unsorted household rubbish. When disposing of this device, ensure compliance with local ordinances and regulations.

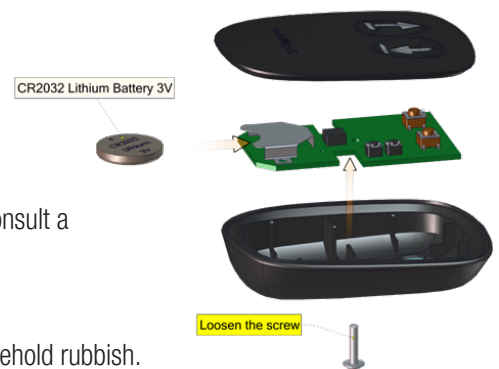

**Replacing the remote control battery:**

1. Loosen the screw (Torx TX 6) on the rear of the remote control.
2. Remove the back panel
3. Swap the battery
4. Refit the back panel and make sure that the remote control is working correctly

## 11. Service Inspections

Under normal conditions of operation, a service life of >5 years may be expected, provided that the product is maintained in accordance with the guidelines of the producer. In addition to the general maintenance described in section 9, we recommend routine annual inspections (+/- one month) performed by a qualified service technician.

For models with the automatic service indicator activated, the Raizer will begin to flash a service message when it is time for the service inspection. Also, an acoustic alarm will sound to remind you that service is due.

In case the automatic service indicator has been deactivated, a label on the product will inform you accordingly, and service intervals may be arranged with the local dealer at your discretion.

The dealer you have bought the Raizer from will offer this service, but if you wish to use another service provider, you as the owner of the Raizer are responsible for ensuring that the chosen service technician is suitably qualified in the product in question.

 For safety reasons it is very important that these inspections are maintained, since lacking or improperly performed inspections may result in personal injury.





All service inspections performed must be logged in the service logbook.

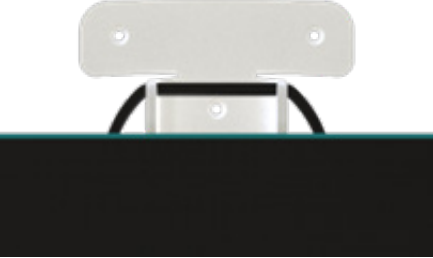

## 12. Spare Parts & Accessories

 **IMPORTANT:** It is important to use only original spare parts. Replacement of parts may only be undertaken by a qualified service technician. The use of non-original spare parts may void the right of complaint. Furthermore, product safety may be compromised, which may pose a risk to personal safety.

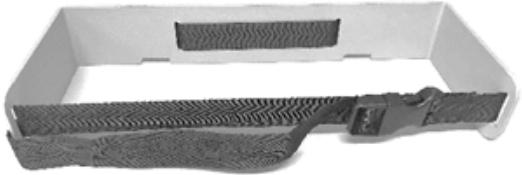
Part No.	Description	Photo
105192	Battery Charger, 15W, Magnetic Male	
105082	Charger Cable USB	
107463	Carry Case (Including Quick Guides)	

107240	Cover for Seat	
107693	Wall Bracket (Optional Equipment)	
107273	Trolley (Optional Equipment)	
107374	Clip and Belt	
104913	Hanger for Trolley	

<p>103314</p>	<p>Triple Wheel for Trolley, 2 pcs. (Optional Equipment)</p>	
<p>103313</p>	<p>Bike Bracket Kit, Trolley (Optional Equipment)</p>	
<p>103741</p>	<p>Disposable Hygiene Cover (10 pcs.) (Optional Equipment)</p>	
<p>102890</p>	<p>Battery 12V 5Ah LifFePo4 Raizer</p>	
<p>107230</p>	<p>Stop Device for Raizer II</p>	

### 13. Troubleshooting

You can find helpful videos which will provide you with information on signals and troubleshooting, assembly and disassembly at our DHG website: [www.dhg-healthcare.com](http://www.dhg-healthcare.com)

### 14. Electrical Diagram

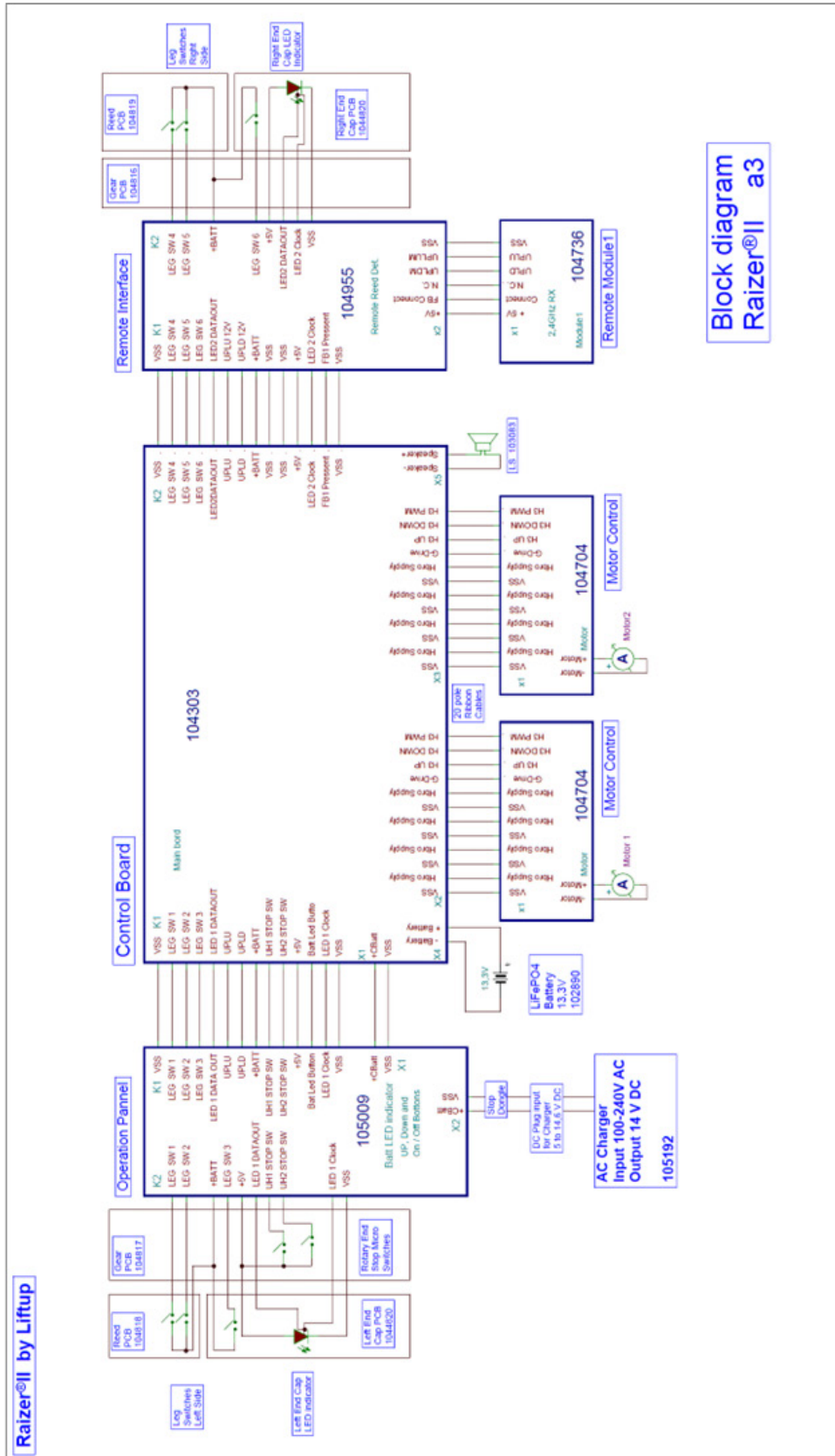

Block diagram  
Raizer® II a3

## 15. Disposal

It is the duty of the owner to dispose of the product in accordance with the regulations applicable at the time. Please note that the control unit and remote control contain batteries, which must be disposed of separately.



NOTE: Do not dispose of batteries or electrical or electronic equipment with unsorted household rubbish. When disposing of this device, ensure compliance with local ordinances and regulations.



**This Page is Left Intentionally Blank**

**This Page is Left Intentionally Blank**

**This Page is Left Intentionally Blank**



Moving Health Forward

**PRESSURE ULCER PREVENTION**  
**SAFE MOVING & HANDLING**  
**SPECIALIST THERAPIES**  
**BATHROOM SAFETY**  
**RENTAL & SERVICE SOLUTIONS**



Direct Healthcare Group Ltd  
Withey Court, Western Industrial Estate  
Caerphilly, United Kingdom  
CF83 1BF

T: +44 (0) 800 043 0881  
F: +44 (0) 845 459 9832  
E: [info@directhealthcaregroup.com](mailto:info@directhealthcaregroup.com)

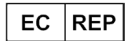

Direct Healthcare Group Sverige AB  
Torshamnsgatan 35, SE-164  
Kista, Sweden

T: +46 (0) 8 557 62 200

**Australian Sponsor:**  
Direct Healthcare Group Pty Ltd.,  
68 Howe Street, Osborne Park,  
Western Australia 6017

T: +61 (0) 423 852 810



LIT-00155 Issue 01  
Date: January 2023

[DHG-HEALTHCARE.COM](http://DHG-HEALTHCARE.COM)