



Moving Health Forward

EN User Manual

# VENDLET

## Standard





Congratulations on your new VENDLET. The VENDLET is used for handling bedridden clients, for example:

- Turning the client to lateral, prone or supine positions
- Moving the client from one side of the bed to the other
- Repositioning the client up in the bed
- Mobilising the client in and out of bed

This manual covers VENDLET Standard.



Max. user weight is 250 kg

The instructions in this manual must be followed. DHG shall not be liable should VENDLET Standard be used, modified, or assembled in a way that is not described in this manual.

This manual is divided into three parts:

- Part 1 contains general information that is useful to everyone responsible for the purchasing, examination, use, assembly, and maintenance of VENDLET Standard.
- Part 2 is a user manual containing information about the operation and daily maintenance of VENDLET Standard.
- Part 3 is a technical manual containing information about the assembly, maintenance, and service of VENDLET Standard.

## Contents

### Part One: General Information

|                                    |    |
|------------------------------------|----|
| Intended Use .....                 | 04 |
| Product Description .....          | 04 |
| Bed & Mattress Compatibility ..... | 06 |
| Warranty & Service Life .....      | 07 |
| Symbols .....                      | 08 |

### Part Two: User Manual

|   |    |
|---|----|
| Operation .....                           | 09 |
| Attaching the Sheets .....                | 14 |
| Evacuation .....                          | 16 |
| Daily Maintenance & Troubleshooting ..... | 17 |
| Unpacking .....                           | 20 |

### Part Three: Technical Manual

|                              |    |
|------------------------------|----|
| Parts List .....             | 20 |
| Mounting .....               | 21 |
| Quick Guide Location .....   | 26 |
| Additional Accessories ..... | 26 |

|   |    |
|---|----|
| Final Inspection List .....               | 27 |
| Dismounting, Storage & Remounting .....   | 28 |
| Maintenance/Check .....                   | 28 |
| Troubleshooting - Technicians .....       | 30 |
| Technical Data .....                      | 31 |
| Electromagnetic Compatibility .....       | 32 |
| Environmental Conditions & Disposal ..... | 32 |

## PART ONE: GENERAL INFORMATION

### Intended Use

VENDLET Standard may be used for moving clients to a lateral, prone, or supine position, from one side of the bed to the other, or, to reposition them further up in bed. VENDLET Standard may also be used in connection with mobilization in and out of bed.

VENDLET Standard protects the caregiver from physical strain and heavy lifting in connection with the handling of immobile clients. Clients are turned/handled by pressing a hand control whereby the caregiver may support the client and ensure their correct and comfortable positioning. This provides room for increased awareness in the care, which boosts employee job satisfaction and client well-being.

To the client, the turning process becomes uniform and steady as the sheet supports the body over its full length.

### Target group

The target group is adult clients who are being cared for, dressed, washed etc. in bed. This will often be clients who are lifted in and out of bed or clients who are mobilized using a standing aid. Hence, the user will typically be clients with few physical and/or cognitive resources and palliative clients.

VENDLET Standard is also suitable for clients at risk of developing pressure ulcers. The uniform and steady transfer with the sheet minimizes friction and the associated shear that can damage the tissue and cause pressure ulcers. Furthermore, VENDLET Standard is often seen to have a positive effect on clients suffering from spatial awareness.

The VENDLET Standard is intended for adult clients weighing between 30 and 250 kg, with a height above 146 cm and a body mass index (BMI) above 17.



For clients weighing less than 50kg take extra care not to lift the client from the bed when the system is in operation.

### Contraindications

Do not use the Vendlet Standard for clients with unstable fractures, gross oedema, burns or equilibrium disorders.

Prior to the first use of VENDLET Standard, it is important to assess whether VENDLET Standard is suitable for the client in question. It may be necessary to take special precautions, for example if a client is very restless in bed or has an untypical anatomy.

### Independent living

VENDLET Standard is not designed to be operated by the clients themselves.

### Staff

Before using VENDLET Standard, it must be ensured that the caregivers/operators have read “Part 2 – User manual” and that the manual and quick guide are available by the bed.

### Environment

VENDLET Standard can be used in all application environments (1-5), e.g. hospitals, nursing homes and domestic / private homes.

### Product Description

VENDLET Standard consist of two bars fitted with motors. The bar on the left side of the client has a blue colour marking and the bar on the right side of the client has a red colour marking.

Each motorized bar has a groove which makes it possible to attach the edge strip of the turning sheet to the bars. When the bars are running, the turning sheet will be dragged between the two bars, making it possible to move it from side to side.

A slide sheet is inserted under the turning sheet in order to reduce the friction of the turning sheet against the mattress.

Four corner posts are fitted with a build-in actuator in order to raise and lower the bars with the press of a button.

VENDLET Standard can be adjusted in height, which makes it easy to adapt the system to the individual mattress and bed.

Furthermore, VENDLET Standard consist of a control unit and a hand control. The control unit is placed underneath the bed, normally on the base frame.

VENDLET Standard is telescopic in length and can be extended from 200 to 220 cm.

When the bars are raised VENDLET Standard works as side rails.

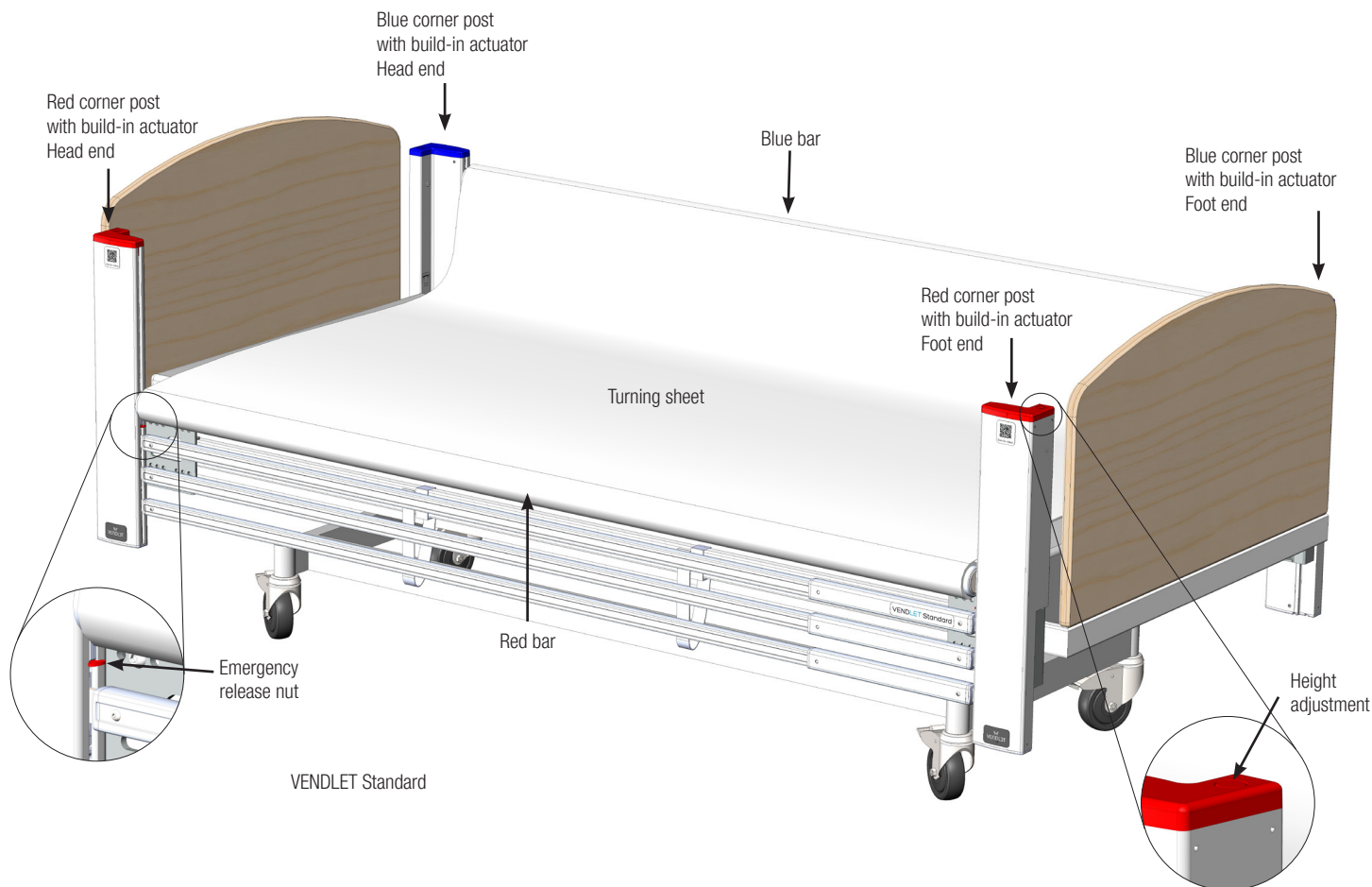

### How VENDLET Standard Works

VENDLET Standard is switched on by double-clicking the  on the hand control. VENDLET Standard produce a “beep” upon activation and the green diode over the power symbol turns on.

When VENDLET Standard hasn't been used for 90 seconds, the system produces a “beep-beep” sound, the diode turns off, and then VENDLET Standard is turned off.

When VENDLET Standard is turned on, the bars can be turned in both directions or raised or lowered. The colour coding on the bars relates to the colours on the hand control buttons.

The speed of the bars can be reduced to 75% or 50% of normal speed.

Press and hold the individual buttons long enough to obtain the desired operation; the motors will stop when the button is released. Likewise, you may stop an activated function by clicking the .

The emergency release nut must only be used in case of emergency (see page 21) or malfunction of the actuators.

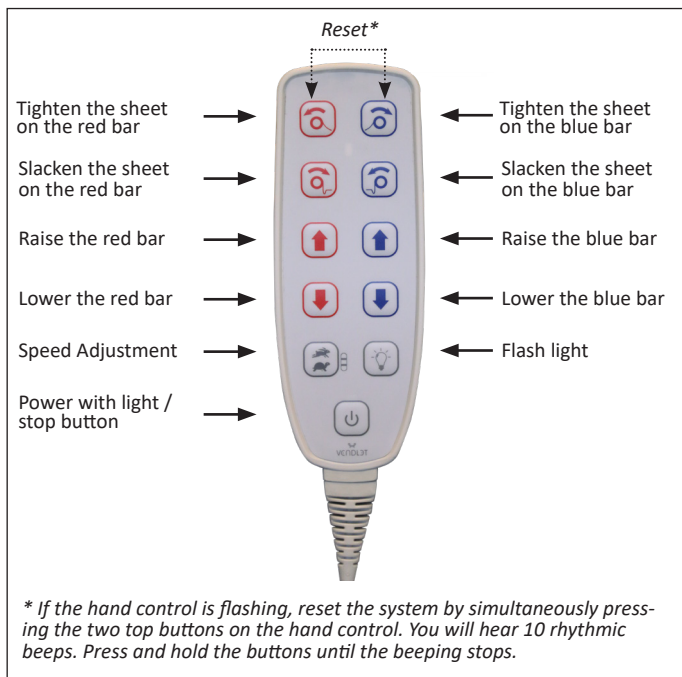

VENDLET Standard hand control



Be aware, that the client does not get too close to the edge of the bed, as there is a risk of falling out of the bed.



Do not use VENDLET Standard if the bars can not be elevated properly.



Lowering the bed to a very low position may leave the corner post close to the floor. Consequently, you should not place your feet under the corner posts.



The client must not hold on to the edge of the turning sheet or bar during the transfer.

**Stop button**



The power button  also functions as a stop button.

If the hand control button controlling the tightening of the sheet fails, the operation can be stopped by pressing the  button.

**Accessories**

**Additional hand control:**

An additional hand control can be connected if a hand control is required on both sides of the bed.

**Wider sheets:**

Wider turning sheets and slide sheets are also available if VENDLET Standard is to be used on wider beds, see page 14.

**Bed & Mattress Compatibility**

VENDLET Standard is intended for mounting on a wide range of hospital and care beds and with a wide range of mattresses.

The following bed and mattress requirements must be met.

**Bed requirements**

The bed must meet the EN 60601-2-52 standard or the expired EN 1970 or EN 60601-2-38 standards.

The bed must have a square steel frame (dimensions H 45-78 mm, W min. 20 mm, L min. 1830 mm) without protrusions. Inner distance between the head- and foot board must be at least 200 cm. The bed width is not crucial as extra wide turning sheets and slide sheets are available.

VENDLET Standard can be mounted on most beds with these dimensions. But situations where VENDLET Standard cannot be mounted can occur.

When the bar is up on the side where the turning sheet is being tightened, the client will be turned. If, on the other hand, the bar is down on the side where the turning sheet is being tightened, the client will be moved towards the edge of the bed. These fundamental principles provide you with a number of ways to move and/or transfer clients. See the "How to use VENDLET Standard" section in "Part 2 – User Manual" for further details.

VENDLET Standard can be operated by only one caregiver.

**Warnings**



As it is recommended that the client does not operate VENDLET Standard themselves, the hand control must be placed on the outside of the bed before leaving the client.



Do not place the hand controller on the side rails, use the bracket provided.



Always, keep focus on the client when using VENDLET Standard.



If the client has long and loose hanging hair, the hair could in some situations be rolled onto the bar. Therefore, long loose hair should be collected before moving and handling the client.

with relevant training, see page 28.



The maximum user weight and safe working load of the bed must not be exceeded following the installation of VENDLET Standard, see page 22.

### Mattress Requirements



The mattress must meet the requirements of the bed manufacturers and be suitable for the bed.

The maximum user weight specification of the mattress must not be exceeded.



Following the mounting of the VENDLET Standard, the distance between the mattress sides and side rails must be minimum 2.5 cm and maximum 4 cm, see page 21.



If the mattress is soft and easily compressible, it must be ensured that there is no entrapment hazard due to extra compression at the edge of the mattress.

When alternating air mattresses are used, it should be possible to inflate the mattress to a firm state before VENDLET Standard is operated. Soft mattresses will increase the friction against the mattress and create an uneven base which will be uncomfortable for the client when VENDLET Standard is operated.



If the client changes mattress, the VENDLET installation must be evaluated. A new mattress might change the conditions and necessitate the reinstallation of VENDLET Standard to reduce the risk of entrapment.

## Warranty & Service Life



















DHG provides a 2-year factory warranty on VENDLET Standard. The warranty is void if the product is not used, handled and maintained in accordance with the guidelines in this manual. Opening the control unit, the bar, the corner post, or the hand control will also void the warranty.

The warranty does not include the sheets.

The VENDLET Standard service life is 10 years. The service life may be significantly extended if the product is used and handled with care and maintained in accordance with the guidelines in this manual.







The VENDLET Standard should be serviced annually by a person

## Symbols





|   |  |
|---|--|
|    | CE marking: The product complies with the Medical Device Regulation (EU) 2017/745  |
|    | This product is a medical device   |
|    | Legal manufacturer   |
|    | Date of manufacture  |
|    | Serial number  |
|    | Item no. / Catalogue number: 7 digits  |
|    | Unique Device Identification   |
|    | Consulting the manual is mandatory   |
|    | Warning triangle indicates when special attention is necessary   |
|    | For indoor use   |
|   | This product is a class II equipment (IEC 61140)   |
|  | The product is a type B equipment according to EN 60601-1  |
|  | Max. user weight   |
|  | Electronic scrap. When disposing of the products, sub-components should be recycled  |
| Washable  | This product is washable according to EN 60101-2-52  |
| U In: 100-220 VAC @ 60 Hz or 100-230 VAC @ 50 Hz                                    | The mains voltage must be 100-220 Volt AC @ 60 Hz or 100-230 Volt AC @ 50 Hz   |
| 350 W   | Max power consumption is 350 W (SMPS: Switch mode power supply).   |
| I In: max. 4,5A   | The current used is max 4,5 A  |
| Int.: 10% - 2/18min on/off  | The system should only be used 10% of the time. After 2 min of continuous use it requires 18 min rest.                       |
| Max 350W/80 sec./ 175W/40sec @25°C  | In continuous use at 25°C 350 W can be supplied for 80 sec - then the power consumption will be reduced to 175 W for 40 sec. |
|  | This product must be stored between 0 and 50°C   |
|  | This product must be used between 5 and 40°C   |
|  | This product must be stored between 20 and 90 % humidity at 30°C   |
|  | Keep dry (when stored)   |

|      |                           |
|------|---------------------------|
| Rev. | Revision no. of the label |
|------|---------------------------|

### Hand control symbols

|   |  |
|---|--|
|  | Power / stop button                      |
|  | Speed Adjustment                         |
|  | Flash light on hand control              |
|  | Tighten the sheet on the red or blue bar |
|  | Slacken the sheet on the red or blue bar |
|  | Raise the red or blue bar                |
|  | Lower the red or blue bar                |

### Symbols only on sub components

|   |   |
|---|---|
|   | Connect control unit extension to control unit  |
|  | Connect battery to control unit   |
|  | The hand control and the control unit complies with the EMC Directive 2014/30/EU and the Low Voltage Directive 2014/35/EU |
|  | The component complies with the EMC regulation of Australia and New Zealand.  |
|  | The component complies with China RoHS.   |
| Type + item   | Product no/catalogue no   |
| Date  | Date of production  |
| W/O   | Work order  |



The product / system label is placed on the corner posts at the foot end.



## PART TWO: USER MANUAL

### Operation

Handling clients with VENDLET Standard enables caregivers to work on a one-to-one basis: one hand is used to operate the hand control and the other hand is free to guide the arms and legs of the client. In order to improve the safety and well-being of the client, we recommend that you place the hand holding the hand control on the shoulder of the client or similar.

You should always use the resources of the client. For example, if the client can move his/her arm to the side, he or she should do so.



When lowering side bars avoid trapping of bedding, hair or limbs.



Always, keep focus on the client when using VENDLET Standard.



Remember to leave the hand control on the outside of the bed before leaving the client.







Not to be used in an oxygen rich environment.

### How to use VENDLET Standard

#### Turning

VENDLET Standard may be used to turn clients. Turning clients with VENDLET Standard is ideally suited for dressing and access to care tasks and hygiene, applying a sling, and repositioning.

Follow this procedure to move a client from a supine position to lying on his/her right side.

1. Turn VENDLET Standard on by double clicking the  button.
2. Press the  button to raise the blue bar.
3. If necessary, press once or twice on the  button to reduce speed.
4. Press the  button to tighten the turning sheet on the blue bar.
5. Place the left arm of the client on his/her stomach or chest the moment before he/she starts turning.





6. Immediately after this, guide the right arm of the client to the side.



7. Then shift the left leg parallel above the right leg.



8. The client now lies on their right side.
9. Press the  and  button to slacken the sheet before the client is left unattended in the bed.

The red bar does not necessarily have to be raised. But if this makes the client or the caregiver feel safer, the red bar could be raised during the process.

Watch a video on how to turn a client on our webpage [www.vendlet.com](http://www.vendlet.com) or scan the QR-code.









### Moving from one side of the bed to the other





VENDLET Standard may also be used to move clients to the side of the bed.

In many situations, this will give the caregiver a better work posture, for example in connection with examinations, training, care tasks, dressing, etc.

Moving the client to the edge also improves the contact with the client.

1. Turn VENDLET Standard on by double clicking the  button.
2. Press the  and  button to lower the bars if they have been raised.
3. If necessary, press once or twice on the  button to reduce speed.
4. Press the  or  button on the hand control to move the client to the side towards you.



5. When your work is done, press the  or  button to reposition the client to the middle of the bed.
6. Press the  and  button to slacken the sheet before the client is left unattended in the bed.

Watch a video on how to transfer a client sideways on our webpage [www.vendlet.com](http://www.vendlet.com) or scan the QR-code.







### Repositioning the client up in the bed

It is a well-known problem that clients often slide down to the foot end, for example when the back support has been raised – even if the knee break on the bed was activated before the back support.

Typically, when a client slides towards the foot end, the turning sheet follows the body of the client. In such situations, you may use VENDLET Standard to move the client up in the bed again.



Work in a zig zag pattern moving the client diagonally from side to side of the bed pulling the turning sheet on to the bar, whilst guiding the sheet to the upper end of the bar.

1. Turn VENDLET Standard on by double clicking the  button.
2. Press the  and  button to lower the bars if they have been raised.
3. If necessary, press once or twice on the  button to reduce speed.
4. Stand next to the headboard and press the  button to slacken the turning sheet.



5. Gently guide the turning sheet to the upper end of the blue bar while pressing the  button to pull the client to the side of the bed.





6. Stop when the client reaches the side of the bed and repeat the procedure on the opposite side.
7. Continue this process until the client has been repositioned up in the bed.
8. Press the  and  button to slacken the sheet before the client is left unattended in the bed.

Watch a video on how to reposition a client higher up in bed on our webpage [www.vendlet.com](http://www.vendlet.com) or scan the QR-code.



### Applying a sling

It is easy to apply a sling on the client when VENDLET Standard is used.

1. Turn VENDLET Standard on by double clicking the  button.
2. If necessary, press once or twice on the  button to reduce speed.
3. Use the turning function of VENDLET Standard to move the client onto his/her side.
4. Place the sling along the back of the client and make sure that the sling is centred and correctly placed in accordance with the instructions of the sling manufacturer.



5. Use the VENDLET Standard turning function to move the client onto their back again.



6. Free the straps on the opposite side.



7. Place all straps in such a way that they are ready to be placed on the lifting beam of the hoist.



Watch a video on how to apply a sling on our webpage [www.vendlet.com](http://www.vendlet.com) or scan the QR-code.







### Prone position

VENDLET Standard can also be used to turn a client to a prone position.

1. Place the client's right arm closely along their body with the palm of the hand facing the hip. Move the pillow and place it close to the right upper arm so that the client comes to lie with his chest on top of the pillow.







2. Turn VENDLET Standard on by double clicking the  button.
3. Press the  button to raise the blue bar.
4. If necessary, press once or twice on the  button to reduce speed.
5. Press the  button to wind the turning sheet onto the blue bar. VENDLET Standard now turns the client. Hold your

hands on the client's shoulder and hip to provide a sense of safety during the procedure. Gently support the client as they are being turned to prone position.



6. Check that the clients head is comfortable and that there is room for breathing.







7. To return to a supine position, press the  button to raise the red bar and press the  button to wind the turning sheet onto the red bar. VENDLET Standard now turns the client to supine position.
8. Press the  and  buttons to slacken the sheet before the client is left unattended in the bed.

Watch a video on how to prone a client on our webpage [www.vendlet.com](http://www.vendlet.com) or scan the QR-code.

### Side rail

If it is assessed that the client must use side rails, VENDLET Standard has integrated side rails.



1. Press the  and  button to raise the bar to the highest position
2. Press the  and  buttons to slacken the sheet before the client is left unattended in the bed.

See page 21 for further information on side rail dimensions.

Watch a video on how VENDLET Standard works as a side rail on our webpage [www.vendlet.com](http://www.vendlet.com) or scan the QR-code.

### Using VENDLET Standard in combination with bed functionality



VENDLET Standard does not interfere with the functionality of the bed. Slacken the turning sheet sufficiently before raising the back, thigh, and/or foot part of the bed.

Under normal circumstances, the bed surface must be level before you use VENDLET Standard.

In some situations, however, it may be advantageous to use the back or foot part of the bed when moving or turning clients. For example, if the client has wide hips and frail shoulders, he/she will rest more comfortably on the bed if the head and foot parts are raised a little before the process.

### Pressure-relieving mattresses

VENDLET Standard does not reduce the effect of either pressure-relieving mattresses or alternating air mattresses. Pressure measurements have been performed which unambiguously show that VENDLET Standard does not have a negative impact on the pressure-relieving properties of the mattresses.

To prevent interference with the function of alternating air mattresses, the turning sheet must be sufficiently slackened before a client is left unattended in the bed.

At the same time, the velcro strap on the slide sheet must not be fastened too tightly on to mattress support platform, see page 14.

We recommend that alternating air mattresses are firmly inflated before patient handling as this brings higher comfort to the client during the process.

### Incontinence

VENDLET Standard can also be used for clients using incontinence sheets. The incontinence sheet should have a minimum width of 125 cm so that it can follow the client's movements during turning. You should not use two small

incontinence sheets as the client in this case will lie on a double edge, which increases the risk of developing pressure ulcers.

The incontinence sheet must not be wrapped around the bars, but instead must hang loosely out over the bars.



### Urine bag and drainage tube

If the client has a catheter or a drainage tube, it may be necessary to adjust the tubes, etc. individually.

Placing the urine bag or drainage tube at the foot end will often be an optimal solution. Should this not be possible, however, you could use long tubes to hang the urine bag or drainage bag on the outer surface of VENDLET Standard.

In such cases, the bag should be placed on the lowest support bar on the side rail by the foot board. Route the tube out between the corner post and the side rail support bars. Be careful to avoid squeezing the tube.

## Attaching the sheets

Place a slide sheet directly on top of the mattress, followed by the turning sheet which is then attached to the two bars.

Slide sheets and turning sheets are available for standard bed sizes and optionally with increased width which makes VENDLET Standard suitable for wider beds as well.

 The turning sheet is a Type B applied part.

| Slide sheet width    | Fits mattress widths | Fits mattress length |
|----------------------|----------------------|----------------------|
| 95 cm (regular size) | 80 - 90 cm           | 205 cm               |
| 95 cm - long         | 80 - 90 cm           | 220 cm               |
| 115 cm               | 95 - 110 cm          | 205 cm               |
| 115 cm - long        | 95 - 110 cm          | 220 cm               |
| 135 cm               | 110 - 130 cm         | 205 cm               |

| Turning sheet width   | Fits mattress widths |
|-----------------------|----------------------|
| 270 cm (regular size) | 80 - 100 cm          |
| 320 cm                | 100 - 130 cm         |

 The material and ingredients of the turning sheet exposed to the patient are biocompatible.

### Slide sheet

1. Fold the slide sheet corner elastic straps around the mattress. Check that the surface is smooth and even without folds. Make sure that the slippery side is facing upwards.



2. Fasten the velcro straps around the edge of the mattress support platform. It is important that the straps are fastened around the edge of the platform under the mattress and not around the bed frame as this will prevent the back, thigh, and foot parts of the bed from being raised.



The straps are long enough for thick mattresses.

The slide sheet is subject to extensive wear and must be checked regularly. The friction of the turning sheet against the mattress will increase if the bed is not fitted with a slide sheet or the slide sheet has been damaged. That will reduce the comfort of the client during moving and handling.

When an alternating air mattress is fitted with a slide sheet, it is important that the velcro straps are not fastened too tightly around the edge of the mattress support platform as this could interfere the function of the alternating air mattress. Consequently, the mattress should be fully inflated while fitting the slide sheet.

### Turning sheet

#### **Attaching the turning sheet before use**





1. Place the turning sheet in the middle of the bed.
2. Press the edge strip of the turning sheet into the groove on one of the bars; begin at the head end of the bed and work your way down to the foot end.



3. The turning sheet must always be placed OVER the bars to

prevent fingers, hair etc. of the client from getting caught under the sheet. If the sheet is placed under the bars, the pulling power will be reduced and the motors will switch off when the turning sheet is pulled in by the bar.



4. Press the  or  button on the hand control and allow approx. two-thirds of the sheet to be pulled in by the bar.
5. Press the edge strip at the opposite edge of the turning sheet into the groove on the other bar.
6. Use this bar to pull in the turning sheet by pressing the  or , button until the sheet covers the mattress evenly with the red line at the centre of the mattress.

**What should I do if the turning sheet is rolled askew on the bars?**

Occasionally, the turning sheet will roll askew on the bars. As such, this is insignificant and VENDLET Standard will still be operable.

This could result in creases in the turning sheet under the client which is undesirable. Hence, we recommend that you aim to smooth the turning sheet if the sheet is askew by more than a hand's width on the bars.

In this situation, you will have to slacken the sheet that has been pulled askew and pull it in again while guiding / smoothing it with your hand.



Watch a video on how to attach the sheets on our webpage [www.vendlet.com](http://www.vendlet.com) or scan the QR-code.



**Changing the turning sheet on an occupied bed**

1. Position the client on his/her side and then move him/her to the centre of the bed.
2. Remove the old turning sheet from the bar facing the back of the client and fold the sheet in layers or roll it. Tuck it underneath the client.



3. Attach the new turning sheet to the bar and press  or  button to roll the new turning sheet onto the bar.



4. Allow approx. half of the new turning sheet to roll onto the bar and stop when the red line on the sheet is at the centre of the mattress. Fold the remaining part of the new turning sheet in layers or roll it. Tuck it under the turning sheet being replaced.



5. Use the opposite bar to move the client to a supine position on top of the new and the old turning sheets.



6. Remove the old turning sheet and attach the replacement sheet to the bar.



Watch a video on how to change the sheet on an occupied bed on our webpage [www.vendlet.com](http://www.vendlet.com) or scan the QR-code.



## Evacuation

Evacuation of clients should happen via the end of the bed, or via the side of the bed.

### Evacuation via the foot end of the bed

1. Remove the footboard.
2. Cut the turning sheet between the mattress and the bar.
3. Evacuate the client via the end of the bed.

### Evacuation via the side of the bed

In case you have power:

1. Lower the bar on the evacuation side.
2. Use VENDLET Standard to pull the client to the side of the bed and evacuate.

In case you do not have power:

1. Manually lift the bar and directly afterwards activate the emergency release, by pushing the emergency release nut upwards.



2. Manually lift the bar and directly afterwards activate the emergency release, by pushing the emergency release nut upwards.





## Daily Maintenance

VENDLET Standard is a reusable medical device intended for long-term use, requiring safe procedures in connection with cleaning and maintenance.

### Daily inspections

VENDLET Standard must be checked daily in accordance with the checklist below. If a "Yes" checkbox is marked, this indicates a desired result. If a "No" checkbox is marked, this indicates a risk in which case VENDLET Standard must not be used.

In case of malfunctions, faults, missing parts, or improper fitting, contact a person with relevant training for inspection or repair.

3. Remember to release the bar in both foot end and head end of VENDLET Standard.
4. Cut the turning sheet between the mattress and the opposite bar.
5. Pull the client to the side of the bed and evacuate.

The emergency release nut must only be used in case of emergency or malfunction of the actuators.

Watch a video on how the emergency release nut works on our webpage [www.vendlet.com](http://www.vendlet.com) or scan the QR-code.



|    | Checklist for daily inspections   | In case of No, do not use VENDLET Standard               |
|----|---|--|
| 1  | Is VENDLET Standard free from visible damage and crooked brackets and fittings?   | <input type="checkbox"/> Yes <input type="checkbox"/> No |
| 2  | Do the bars raise and lower as they should?   | <input type="checkbox"/> Yes <input type="checkbox"/> No |
| 3  | Are the nylon straps attached to the bed frame and all the support bars?  | <input type="checkbox"/> Yes <input type="checkbox"/> No |
| 4  | Is the turning sheet in good condition and does the sheet run over the bars?  | <input type="checkbox"/> Yes <input type="checkbox"/> No |
| 5  | Is the slide sheet fastened around the the edge of the mattress support platform and in good condition? Is the slippery side facing upwards?  | <input type="checkbox"/> Yes <input type="checkbox"/> No |
| 6  | Double-click the  on the hand control. Does the green diode on the hand control illuminate? Does everything work when you press the matching hand control buttons? | <input type="checkbox"/> Yes <input type="checkbox"/> No |
| 7  | Has it been verified that the condition of the client and the mattress/bed/client combination have not changed relative to when VENDLET Standard was mounted?   | <input type="checkbox"/> Yes <input type="checkbox"/> No |
| 8  | Are the caregivers familiar with the instructions of this manual and have they received training in the use of VENDLET Standard?  | <input type="checkbox"/> Yes <input type="checkbox"/> No |
| 9  | Is the quick guide located at an easily accessible spot near the bed?   | <input type="checkbox"/> Yes <input type="checkbox"/> No |
| 10 | Has it been verified that the date of the next annual inspection has not been exceeded?   | <input type="checkbox"/> Yes <input type="checkbox"/> No |

## Cleaning and washing instructions

### ***Cleaning of electrical and mechanical parts***

The VENDLET Standard is machine washable by automatic washing systems according to EN 60101-2-52.

If cleaned manually:

Clean the electrical and mechanical parts with a damp cloth with water or a mild soap solution and then wipe the parts with a dry cloth. You may also use water under pressure, but the system must not be hosed down directly with a high-pressure cleaner.

Disinfection:

You could also use a dry cloth with disinfectant. All common disinfectants for normal use present in care homes and hospitals may be used.

If using washing machine:

Only flat squirt nozzles are allowed. An approved setup could be:

1. Water Pressure 3 bar, water volume 5,61 L/min, dispersion angle 120° flat squirt nozzle.
2. 2 min washing with 70° C water at a pH-value 5-8, with cleaning agent.
3. 20 s rinse with 85° C at a pH-value 5-8 and 0,2% rinsing solution
4. 10 min cooling at 20° C ambient temperature

When washed by automatic washing machine, VENDLET Standard must dry for 24hr before use.

Mounting during washing:

Raise both side rails and turn the motor bars so that groove for attaching the turning sheet is facing downwards.

The components should be mounted with the plug inserts facing downwards or situated so that they are protected from direct impact from the water nozzles. The lid covering the cable inserts on the control box must be closed during the entire cleaning procedure. During washing all electrical sockets/outlets in the control unit and the control unit extension must be fitted with either a cable or a socket cover plug to eliminate ingress of water.

Equally, all cables must be plugged in and guided in such a manner, that there is no apparent strain to the interface between the cable and its connection (for instance between cable and control box). It is furthermore recommended that the control box is situated as far away from the water nozzles as possible.

Industrial high-pressure cleaning is NOT allowed.

Water:

Degree of hardness must not be more than 5° dH and no demineralized water can be used.

Recommended cleaning agents:

- Sekumatic FDR or FRE from Ecolab
- Neodisher Dekonta from Dr. Weigert
- Thermosept NDR from Schulke or similar with a pH-value of 5-8 and in a concentration of 0.5%.

Recommended rinsing solution:

- Sekumatic FKN from Ecolab
- Neodisher BP or TN from Dr. Weigert
- Thermosept BSK from Schulke or similar with a pH-value of 5-8 and in a concentration of 0.2%.

The rinsing agents must not contain caustic solutions. They must not change the surface structure or adhesive properties of the plastic and must not break down grease.



The systems must not be hosed down with high pressure cleaner



Interconnecting cables must remain plugged in during cleaning to prevent the ingress of water



Cleaning with steam cleaner is not permitted

Controller rated to IPX6

### ***Washing instructions, slide sheet***



Recommended washing temperature: 60°C  
Do not add fabric conditioner.



Do not tumble-dry



Do not iron

**Washing instructions, turning sheet**



Recommended washing temperature: 90°C  
Max. 4% shrinking







Tumble-dry at normal temperatures



Iron or mangle at high temperatures

**Troubleshooting - daily use**

| Problem  | Checklist   |
|--|---|
| Is the light flashing on the hand control?   | Reset the system by simultaneously pressing the  and  buttons on the hand control. You will hear 10 rhythmic beeps. Press and hold the buttons until the beeping stops. |
| VENDLET Standard does not work   | Is the control unit connected to 230V outlet and is the power on?<br>Is the green diode on the control unit illuminated?  |
|  | Are all plugs properly connected on the control unit?   |
|  | Is the green diode on the hand control illuminated?<br>Double-click the  button to activate the system.  |
| One of the bars does not work  | Are all plugs properly connected on the control unit?   |
|  | Is the cable to the bar intact?   |
| One or both bars do(es) not turn when the client is lying in bed                           | Is the turning sheet running under the bars?<br>The sheet must be over the bars.  |
|  | Are all plugs properly connected on the control unit?   |
| The hand control buttons are not working   | Are all plugs properly connected on the control unit?   |
|  | Double-click the  button to activate the system.  |
|  | Is the correct hand control used? The VENDLET Standard only works with the VENDLET Standard hand control (see page 8).  |
| One of the bars will only turn in one direction  | Are all plugs properly connected on the control unit?   |
|  | Is the cable to the bar intact?   |
| The symbols on the hand control do not match the action when VENDLET Standard is activated | Are all plugs properly connected on the control unit?   |
| The actuators cannot be raised/ lowered or do not move together                            | Are all plugs properly connected on the control unit?   |

## PART THREE: TECHNICAL MANUAL

### Unpacking

VENDLET Standard is delivered in 2 boxes. They both have a weight of approx. 25 kg.

VENDLET Standard is preassembled on delivery, ready for mounting on the bed. Check the packaging and contents for signs of damage and contact the distributor in case of obvious damage.

### Parts List

|   |      |                                     |
|---|------|-------------------------------------|
| 1 | unit | Blue side complete                  |
| 1 | unit | Red side complete                   |
| 1 | unit | Suspension bracket for control unit |
| 1 | unit | Control unit                        |
| 1 | unit | Control unit extension              |
| 1 | unit | Control unit extension clip         |
| 1 | unit | Control unit extension cable        |
| 1 | unit | Power cable - 230 V                 |
| 1 | unit | Hand control                        |
| 1 | bag  | 16 mounting bolts                   |
| 8 | unit | Mounting plates                     |
| 1 | unit | Slide sheet                         |
| 1 | unit | Turning sheet                       |
| 1 | unit | Quick guide                         |
| 1 | unit | Manual                              |

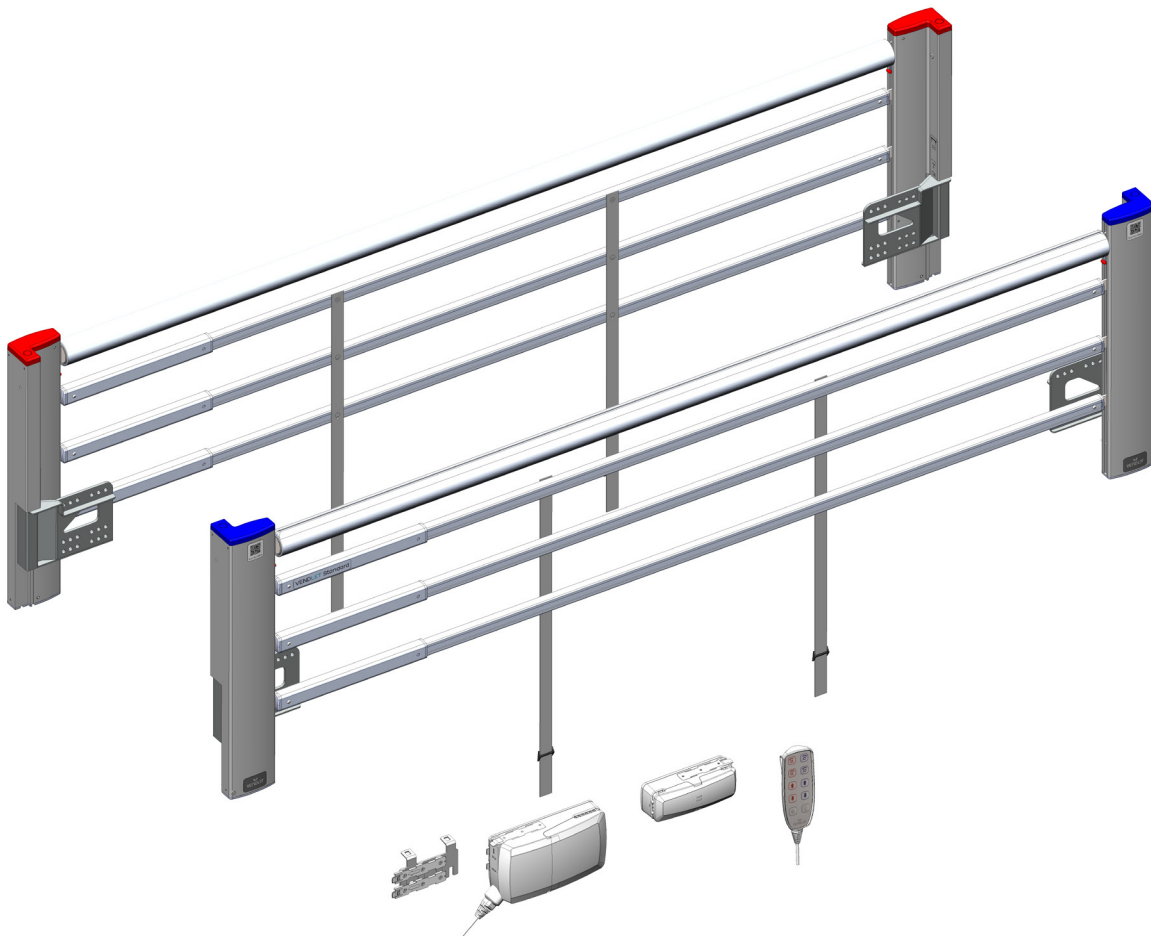

## Mounting

VENDLET Standard should always be installed by a person with relevant training.



Incompatible mattresses can cause risk of entrapment.



Qualified personnel only to perform the installation of the VENDLET Standard.

## Preparations

### Tools and bolts

- Allen key 6 mm
- Nipper
- Button head bolts: 16 x M8 x 40 mm

### Dimensional requirements, side rails

If the bed is equipped with side rails, these must be removed before mounting VENDLET Standard. VENDLET Standard has been tested and approved to function as side rails in accordance with the requirements of EN 60601-2-52:2010.

When mounting VENDLET Standard you should take the following dimensions into account:

A:

A distance of 2.5 – 6 cm (A) is recommended between the mattress and the side rail on both sides of the mattress. If the distance is above 6 cm the risk of entrapment must be evaluated for the specific combination of bed, mattress, patient and VENDLET system.

Likewise, it is important that the mattress guides are suitable for the mattress and will hold the mattress in

place.

If necessary, use one or two 15 mm spacers, to pull the mounting bracket away from the bed frame

B:

In order to meet the side rail requirements, the upper edge of the bars must be mounted at least 22 cm (B) above the mattress surface.

C:

The lower part of the side rail must always be at least 12 cm (C) above the ground.

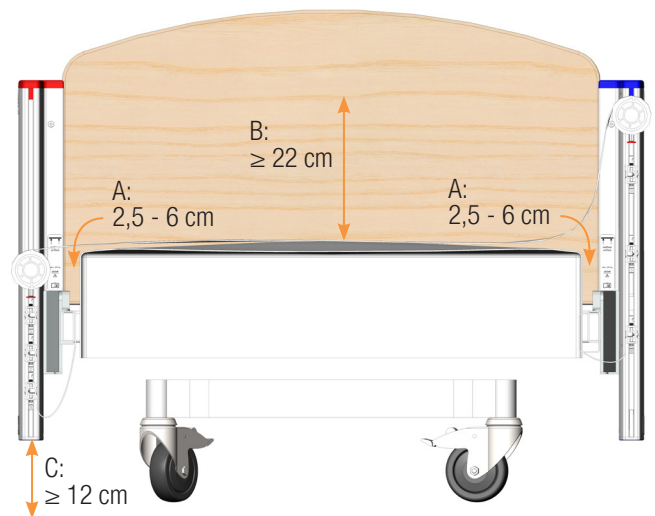

D:

The length must be adjusted in order to ensure that the gap between the board and VENDLET Standard is less than 0,8 cm or more than 2,5 cm (D). However, the gap must not exceed 6 cm.

VENDLET Standard is telescopic in length and can be extended from 200 cm to 220.

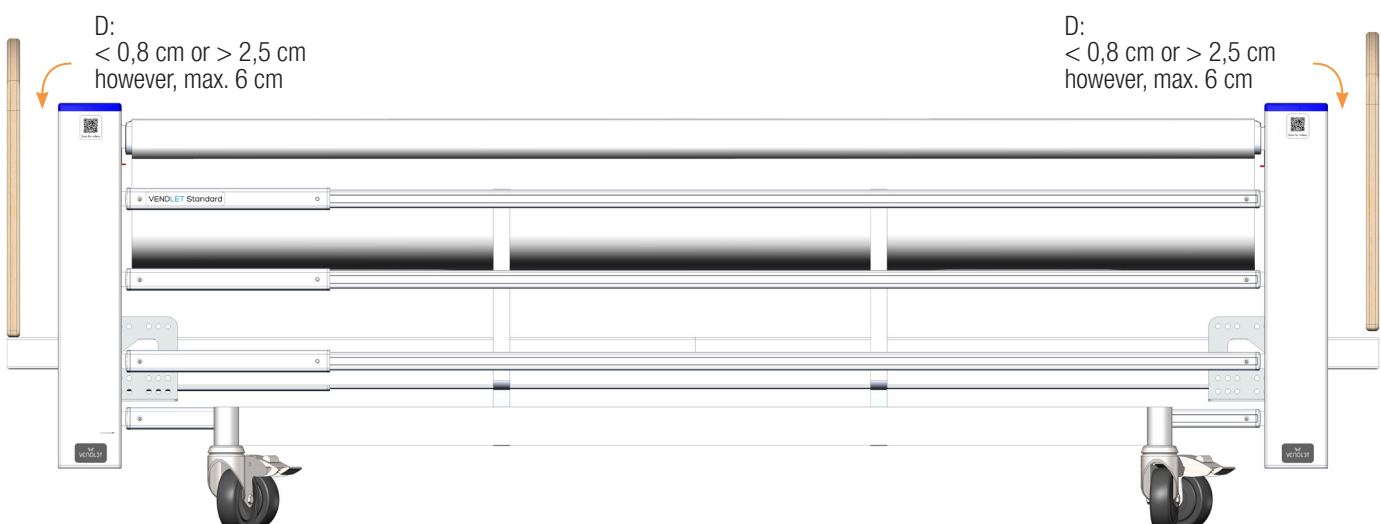

**Maximum loads**

The max. user weight for VENDLET Standard is 250 kg.

Since VENDLET Standard is always mounted on beds, it is important to consider the whole solution. You should always check the safe working load (SWL) of the bed and ensure that the combined weight of the client, VENDLET Standard and any other equipment on the bed never exceeds this limit.

In home care situations the weight of other equipment is estimated to be 25 kg. In this case the SWL of the bed must be at least 317 kg to be able to handle a user weight of 250 kg:

|                  |   |                  |   |                 |   |                  |
|------------------|---|------------------|---|-----------------|---|------------------|
| Max. user weight |   | VENDLET Standard |   | Other equipment |   | Required Bed SWL |
| 250 kg           | + | 42 kg            | + | 25 kg           | = | 317 kg           |

In intensive care situations the weight of other equipment is estimated to be 55 kg. In this case the SWL of the bed must be at least 347 kg to be able to handle a user weight of 250 kg:

|                  |   |                  |   |                 |   |                  |
|------------------|---|------------------|---|-----------------|---|------------------|
| Max. user weight |   | VENDLET Standard |   | Other equipment |   | Required Bed SWL |
| 250 kg           | + | 42kg             | + | 55 kg           | = | 347 kg           |

Please note that the safe working load of the bed may have an impact on the maximum user weight, as illustrated in the below examples:

| SWL of the Bed | VENDLET Standard | Other Equipment | Maximum User Weight |
|----------------|------------------|-----------------|---------------------|
| 235kg          | 42kg             | 25kg            | 168kg               |
| 250kg          | 42kg             | 25kg            | 183kg               |
| 385kg          | 42kg             | 35kg            | 250kg               |

**Mounting**

Grab the motor bar when lifting VENDLET Standard - not the support bars.

**Attaching a side**

The sides are determined by the supine position of the client. The red bar must be placed on the right side and the blue bar on the left side of the client.

The bars must be in upper position during mounting.

1. Attach the mounting plates at the top with a button head bolt. Do that on both ends.

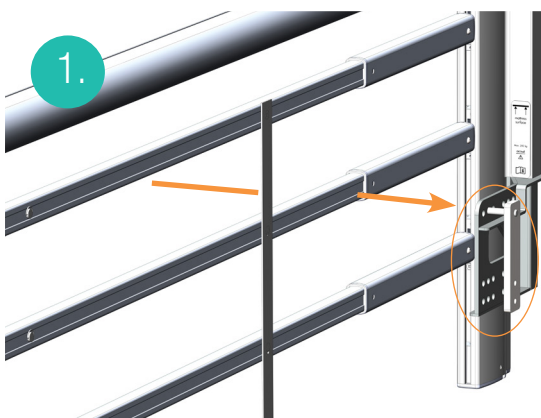

2. Place the side on the steel frame of the bed.

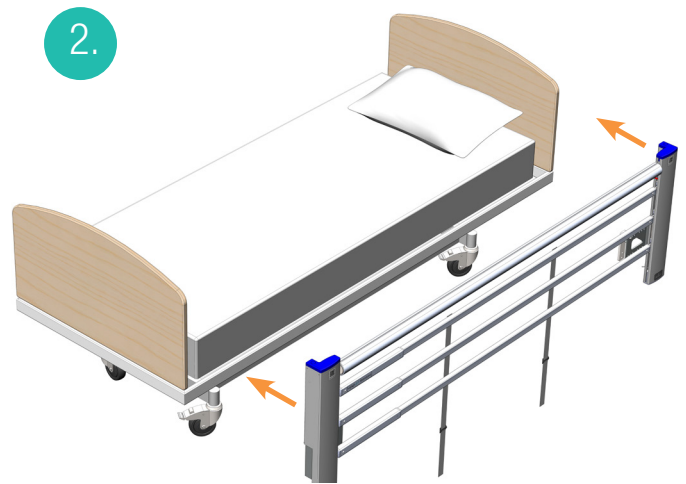

3. Place the corner post as close to the headboard as possible. Fit the button head bolt at the bottom of the bracket.

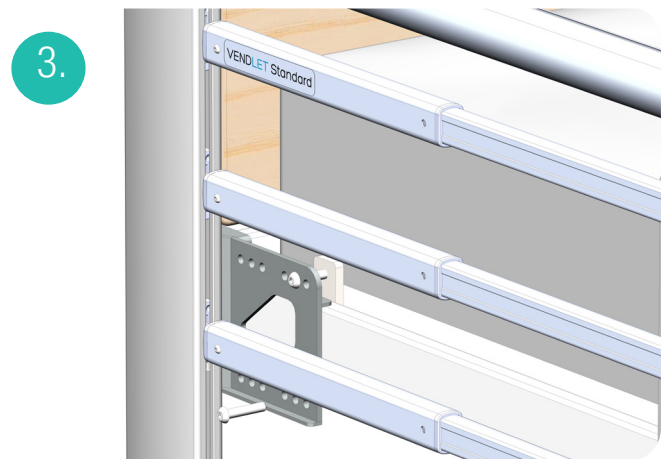

4. Tighten the button head bolts evenly at the head end.

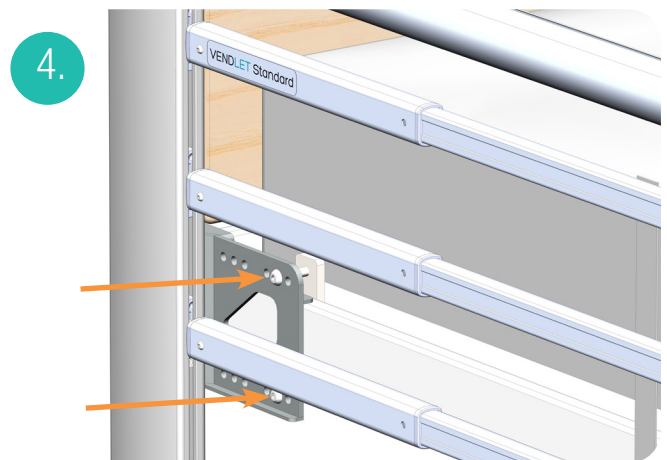

5. Adjust the length of the side and place the corner post as close to the footboard as possible. Fit the button head bolt in the bottom of the bracket. Tighten the button head bolt

evenly. Tighten the bracket at the foot end.

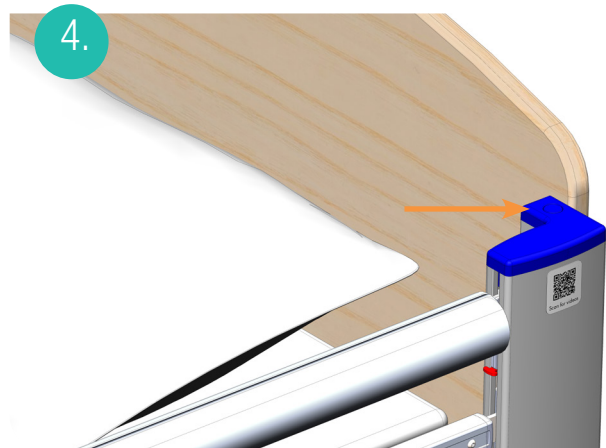
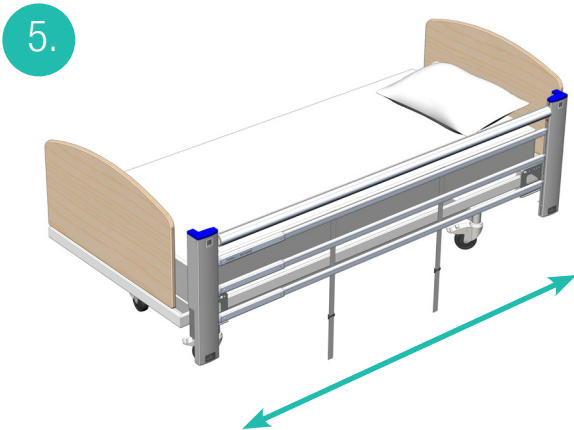

6. Attach the outer mounting bracket in both ends and tighten the button head bolts evenly.

5. Simultaneously, lift the corner post until the surface of the mattress is in level with the mark inside the corner post.

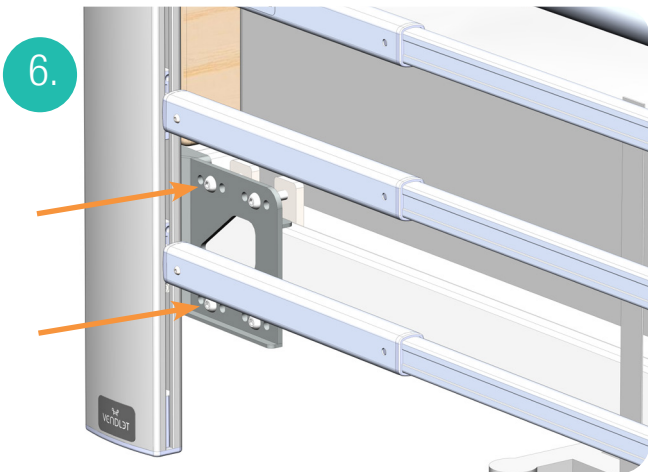

7. Ensure that the distances meet the dimensional requirements described on page 21.

6. Repeat the procedure at the other three corner posts. Make sure all 4 corner posts are left at the same height.

**Height adjustment**

Always adjust the height of VENDLET Standard in accordance with the instructions on page 21 and the height of the mattress.

The height can be adjusted up to 12 cm. The height adjustment has 10 possible positions.

1. Make sure, that the surface of the bed is flat and horizontal.
2. If the mattress is an alternating air mattress, make sure it's fully inflated.
3. Place the bar in the highest position.
4. Press the small button on the corner post.

7. When the system is raised to the highest position, it can be lowered again.

8. Tighten the side rail straps around the steel frame.



9. The blue side mounted and height adjusted:



**Electrical parts**

***Mounting the control unit***

The control unit is mounted under the bed, usually on the bed frame against the headboard but could also be placed in other locations with free space.

1. Place the suspension bracket in an appropriate location on the base of the bed. Use cable ties.

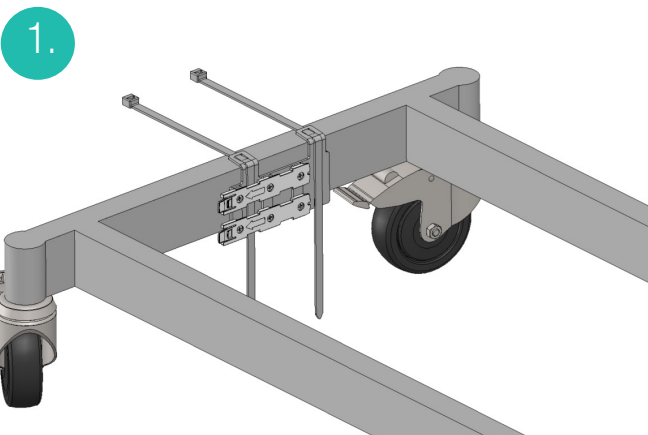

2. The suspension bracket is now placed correctly.

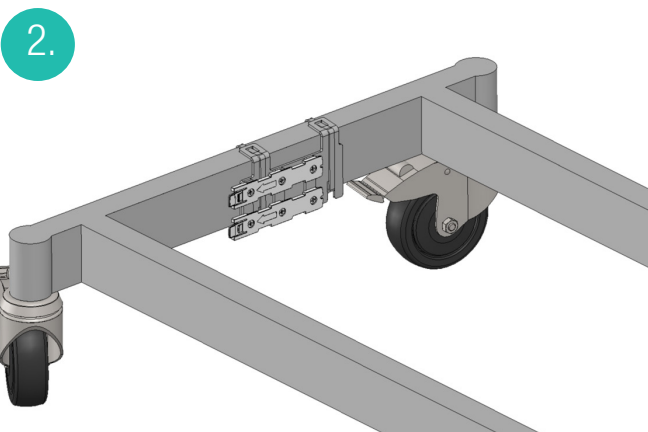

3. Attach the power cord to the control unit.

4. Slide the control unit onto the suspension bracket till it clicks on.

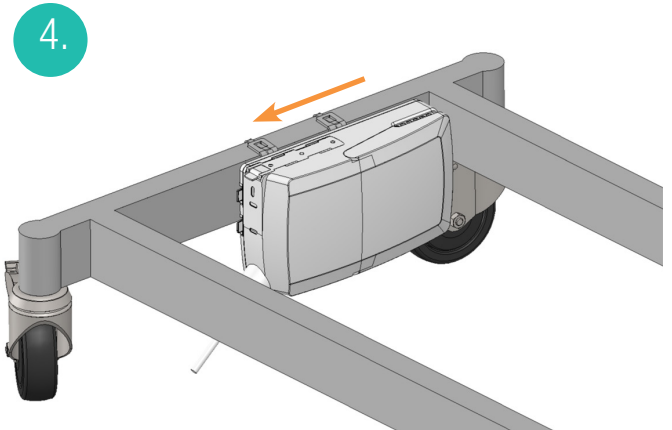

5. Slide the control unit extension on top of the control unit till it clicks on.

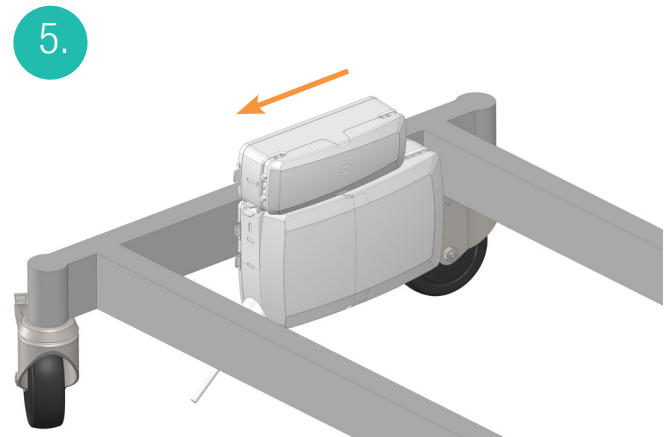

6. If the construction of the bed leaves no room for the extension box on top of the control unit, use two long cable ties to attach the extension box to the frame next to the control unit.





### Connecting the control unit

The hand control should be connected before the power cable is connected to a main plug.

1. Connect the hand control to the control unit in the socket shown below.



2. Connect the control unit at this symbol  to the control unit extension at this symbol 

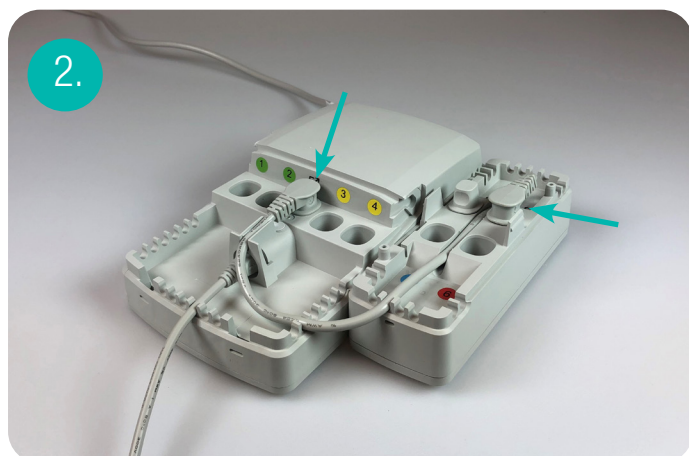

3. Now connect the actuator cables. The blue side actuator cables have plugs with yellow O rings; these are connected to the yellow control unit colour codes.

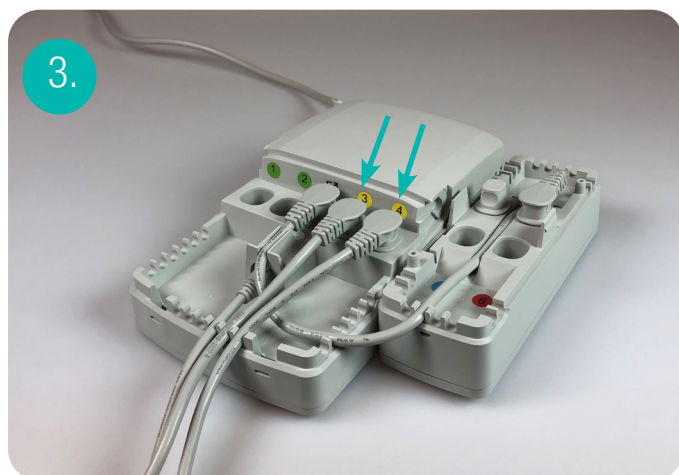

4. The red side actuator cables have plugs with green O rings; these are connected to the green control unit colour codes.

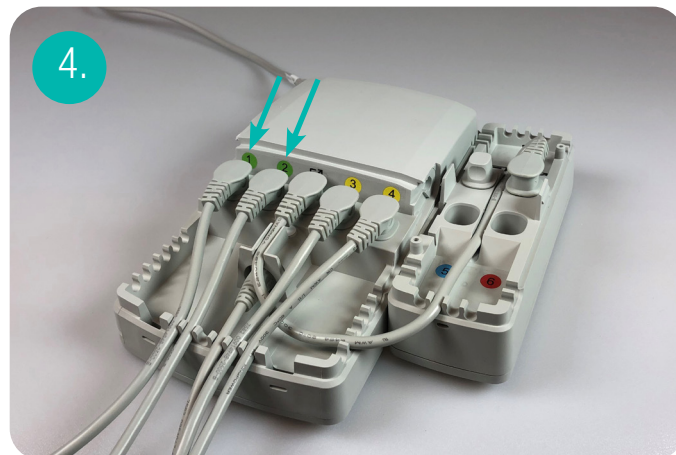

5. The plugs on the blue bar motor cables are fitted with a blue O ring; these are connected to the blue control unit colour code.



6. The plugs on the red bar motor cables are fitted with a red O ring; these are connected to the red control unit colour code.



7. Close the control unit.

## Connecting the power cables

The last step is to connect the control unit power cable to an easily accessible 230V mains plug. The green diode on the control unit illuminates when the power is turned on.

Keep all cables away from the floor and the moving parts of the bed. Loose / excessive cable can be attached to the bedframe with cable ties next to the control unit.



Incorrect handling of cables can cause electric shock or product failure.

- Do not bend, break or cut the power cord or otherwise damage it.
- Do not run over the power cord with the bed.
- Do not insert the power cord into moving parts.
- Unplug the power supply cord before moving the bed.
- Ensure that no cables (power cord or cables from other equipment) are jammed or otherwise damaged when the bed is in use.
- Keep bed components and accessories at least 30 cm away from heated surfaces and direct sunlight.
- Do not position the VENDLET Standard in a way that it is difficult to disconnect the mains plug. The mains plug in the wall is used as an appliance coupler.

## Attaching the sheets

Please refer to page 18-19 for instructions on how to attach the sheets.

## Quick Guide Location

The quick guide should always be placed where it will be visible from the bed and in close proximity to the bed.

## Additional Accessories

### Additional hand control

An additional hand control can be connected if a hand control is required on both sides of the bed.

### Side rail bumper

In certain situations, it can be necessary to protect the restless and agitated clients from bumping into the side rails. The side rail bumpers are easily mounted, and works up and down integrated with the side rails.

### Bed frame bracket

Some bed frames have welding and/or rounded corners on the bed frame which makes traditional mounting of VENDLET Standard complicated. Adequate space for mounting VENDLET Standard is ensured using the Bed Frame Bracket.

### Bracket for Volker 3080 bed

You need to mount a special bracket on a Volker 3080 bed before you can mount VENDLET Standard.

### Multi bracket

Multi bracket is a bracket that can be fitted to Octave beds that do not have an accessible steel frame that VENDLET Standard can be mounted upon.

### Transport and mounting trolley

The transport and mounting trolley for VENDLET provides better protection of the VENDLET during transport and simplifies the entire mounting and transport situation.

You can see more about all accessories on our webpage.

## Final inspection checklist

Always perform a final inspection after completing the installation. The final inspection is carried out by following the checklist below.

If there are ticks in the column “No”, it must be assessed whether VENDLET should be used until the matter is resolved.

| Final inspection checklist  | Yes | No |
|---|-----|----|
| Is VENDLET Standard mounted by a person with relevant training?   |     |    |
| Is the combined weight of the client, VENDLET Standard and any other equipment on/in the bed below or equal to the max. safe working load of the bed? |     |    |
| Have the side rail dimensioning requirements been met (length and height)? (Page 26)  |     |    |
| Can both side rails be raised and lowered without problems?   |     |    |
| Are all corner posts adjusted to the same height according to the mattress? (Page 26)   |     |    |
| Are all emergency release nuts working?   |     |    |
| Are the nylon straps attached to the bed frame and all the support bars?  |     |    |
| Are the nylon straps intact?  |     |    |
| Are the plastic parts intact and without signs of wear?   |     |    |
| Are all wires intact?   |     |    |
| Do both bars slacken and tighten the sheet?   |     |    |
| Does the timer activate when the button is pushed twice within 2 seconds?   |     |    |
| Does the timer turn off after 90 seconds of idle time?  |     |    |
| Is the control unit securely suspended?   |     |    |
| Are all cables securely attached to the control unit?   |     |    |
| Have the lids on the control units been closed properly and are the lids intact?  |     |    |
| Are all loose cables off the floor?   |     |    |
| Is the slide sheet fitted on top of the mattress and properly attached?   |     |    |
| Is the turning sheet fitted in such a way that it runs over the bars?   |     |    |
| Is the quick guide visible and located near the bed?  |     |    |
| Is the VENDLET Standard manual available?   |     |    |
| Have the caregivers been instructed on the use of VENDLET Standard and its functions?   |     |    |
| Has the VENDLET Standard system been signed up for an annual service check?   |     |    |

Date: \_\_\_\_\_

Carried out by: \_\_\_\_\_

Serial no.: \_\_\_\_\_

Bed model: \_\_\_\_\_

Mattress model and dimensions: \_\_\_\_\_

Client: \_\_\_\_\_

Address: \_\_\_\_\_

Date of next service check: \_\_\_\_\_

## Dismounting, Storage & Remounting

### Dismounting

VENDLET Standard may be dismantled and transferred to another bed.

1. Remove the turning sheet and slide sheet.
2. Raise the VENDLET Standard bars to highest position.
3. Disconnect the power cable from the outlet.
4. Disconnect the cables from the control unit.
5. Dismount the control unit by cutting cable ties.
6. Now VENDLET Standard can be dismantled. Loosen the bolts in the mounting plates and turn them aside to lift VENDLET Standard off the bed frame. Optionally, use the mounting trolley to transport VENDLET Standard to a new destination.

### Storage

Store VENDLET Standard in the original packaging until mounting.



Indoor



0° C (32° F) Min  
+50° C (122° F) Max



20–90% at 30°C



Keep dry

### Remounting

Follow the procedure described in the section “Mounting” if remounting is required.

Before remounting, you should check all parts of VENDLET Standard for damage and that the date of the annual service check has not been exceeded, and that VENDLET Standard has been properly cleaned / disinfected.

## Maintenance/Check





### Annual check

VENDLET Standard should be serviced by a person with relevant training annually. This check will ensure that the safety issues pertaining to VENDLET Standard are in compliance with the standard as well as a long service life.

None of the parts of this equipment shall be serviced or maintained while in use with a patient.

The annual check includes the following:

#### Electrical parts

| Control unit no.:  |          |          |           |          |
|--|----------|----------|-----------|----------|
| Check the control unit including cables, plugs and mounting fittings for signs of damage.  |          |          |           |          |
| Check whether the timer deactivates after 90 seconds of idle time.   |          |          |           |          |
| Check whether the green diode is illuminated.  |          |          |           |          |
| When using an extension cable, check whether the cable has the necessary quadrant (1.0 mm <sup>2</sup> ).  |          |          |           |          |
| Hand control no.:  |          |          |           |          |
| Check the hand control, cables and mounting fixtures for signs of damage.  |          |          |           |          |
| Check the functioning of all buttons and whether the green diode is illuminated when the system is active.   |          |          |           |          |
| Check all plugs, cables and relief cables.   |          |          |           |          |
| Check the stop function.   |          |          |           |          |
| Bars   | Red side |          | Blue side |          |
| Check the motors for signs of damage.  |          |          |           |          |
| Check all cables, plugs, and relief cables for signs of damage.  |          |          |           |          |
| Check whether the bar can be operated manually when the motor is disconnected from the control unit.   |          |          |           |          |
| Check whether the motor has full pulling power when you press the  /  and reduced pulling power when you press the  /  by stopping the bar with your hand. |          |          |           |          |
| Actuators  | Head end | Foot end | Head end  | Foot end |
| Check all cables, plugs, and relief cables for damage. Check whether the cables are properly secured.  |          |          |           |          |
| Check whether the cables are properly secured and not hanging loose.   |          |          |           |          |
| Check if the actuators run up and down freely without any missound. Lubricate if necessary.  |          |          |           |          |
| Check for damaged aluminium and plastic parts.   |          |          |           |          |
| Are there any vibrations when the actuator runs?   |          |          |           |          |

**Mechanical parts**

|  |  |
|--|--|
|  | Check for signs of damage, damaged plastic parts and crooked fittings or brackets and missing parts.               |
|  | Check the bars and support bars for dents/deformations.  |
|  | Check whether the groove on the bar is in good shape and works with the Quick Tag attachment on the turning sheet. |
|  | Check that the nylon straps are intact, fitted correctly to the bed frame and support bars.                        |
|  | Check that the motors run correctly, without any strange noises.   |
|  | Check if the wear rings in the bars need to be exchanged.  |

**Sheets**

|  |   |
|--|---|
|  | Is the turning sheet in good condition? |
|  | Is the slide sheet in good condition?   |

**Functional tests**

|  |  |
|--|--|
|  | Do all bolts match the parts list and are they evenly tightened?                         |
|  | Does the mounting meet all side rail dimension requirements?                             |
|  | Check whether it is possible to raise and lower the bars freely and in parallel.         |
|  | Check that the emergency release nuts are working properly.                              |
|  | Check whether the VENDLET Standard works as intended when the hand control is activated. |

**Replacements of parts**

All replacement parts must be installed by a qualified service engineer with relevant training.

## Troubleshooting - Technicians

| Problem   | Checklist  | Repairs   |
|---|--|---|
| VENDLET Standard does not work.                                   | Is the green diode on the control unit under the bed illuminated?  | If not, check that the power is turned on and functional. Check that the power cable is connected to the control unit.  |
|   | Is the green diode on the hand control illuminated?  | If not, make sure all cables are properly mounted and intact. Replace the hand control.   |
|   | Check the backup battery connection for signs of damage.   | If damaged replace the battery and connect VENDLET Standard to the main power to charge the new battery.  |
|   | Is the light flashing on the hand control?   | Reset the system by simultaneously pressing the two top buttons on the hand control. You will hear 10 rhythmic beeps. Press and hold the buttons until the beeping stops.   |
|   | None of the above?   | Contact a person with relevant training.  |
| The bar starts but stops pulling immediately afterwards           | Does the client weigh more than max. user weight?  | If max user weight is exceeded acquire a VENDLET with higher user weight (VENDLET Bari)   |
|   | Is part of the mattress or blanket rolled onto the bar with the sheet?   | Make sure only the turning sheet is rolled on to the bar  |
|   | Is the turning sheet attached correctly?   | Make sure the turning sheet is placed OVER the bar  |
| One of the bars does not work.                                    | Can the bar be turned by hand?   | If not, change the relay cable. If the bar is still locked, change the bar.   |
|   | Is the cable to the bar or the relay cable damaged?  | If damaged, replace the relay cable or the cable for the bar.   |
|   | Is the cable intact?   | Switch the plugs of the two bars. If the same bar still does not work, then the motor of that bar is defect. If the other bar is not working, then the hand control or the control unit is defective. Replace the hand control. If this does not solve the problem, replace the control unit. |
|   | Is the motor malfunctioning?   | Replace the bar.  |
|   | None of the above?   | Contact a person with relevant training.  |
| One or both bars does not work when load is applied.              | Does the turning sheet run over the bar, cf. page 19 of the user manual?   | If the sheet runs under the bar, the motor disconnects when loaded. This is a safety feature.   |
|   | Switch the plugs of the two bars.  | If the same bar still does not work, then the motor of that bar is defective. If the other bar is not working, then the hand control or the control unit is defective. Replace the hand control. If this does not solve the problem, replace the control unit.                                |
|   | None of the above?   | Contact a person with relevant training.  |
| The hand control buttons are not working.                         | Is the plug properly connected to the control unit?  | Mount the plugs correctly in the control unit.  |
|   | Is the cable damaged?  | Replace the hand control.   |
|   | None of the above?   | Contact a person with relevant training.  |
| One of the bars only turn in one direction.                       | Are all plugs properly connected on the control unit?  | Mount the plugs correctly in the control unit.  |
|   | Is the cable to the bar or the relay cable damaged?  | If damaged, replace the relay cable or the cable for the bar.   |
|   | None of the above?   | Replace the bar.  |
| One or more actuators will not move up or down.                   | Is the plug properly connected to the control unit?  | Mount the plugs correctly in the control unit. If the hand control is flashing, reset the system by simultaneously pressing the two top buttons on the hand control. You will hear 10 rhythmic beeps. Press and hold the buttons until the beeping stops.                                     |
|   | Is the cable damaged?  | Replace the corner post, if the cable is damaged.   |
|   | If the actuator still does not work, try changing the channel.   | Replace the corner post if this does not solve the problem. Replace the control unit if the channel in the control unit is faulty.  |
|   | None of the above?   | Contact a person with relevant training.  |
| One or more actuators will not go entirely down.                  | Have the side rail dimensioning requirements been met, cf. page 26? If not, the free movement of the actuator may be affected. | Evaluate the mounting of VENDLET Standard. If necessary remount the system with spacers.  |
|   | Is the emergency release nut working?  | Replace the emergency release nut.  |
| One or more support bars will not move when the bar is lifted.    | Is the plastic slider damaged?   | Contact a person with relevant training.  |
|   | Is the steel connection between the plastic sliders detached?  | Contact a person with relevant training.  |
| The lowest support bar can move up, when the side rail is raised. | Check the small socket screw on the inside of the corner post.   | Replace the socket screw.   |
|   | Check the lower slider for the support bar.  | Replace the lower slider.   |

## Technical Data

In accordance with the Medical Device Regulation (EU) 2017/745, VENDLET Standard is a class I product.

|                               | VENDLET Standard                                      |
|-------------------------------|---|
| Product no.                   | 6300000   |
| Max. user weight              | 250 kg  |
| Control unit:                 |   |
| Power supply                  | SMPS 350W   |
| Mains supply                  | 100-220 Volt AC @ 60 Hz or<br>100-230 Volt AC @ 50 Hz |
| Power rating                  | Max 350 W   |
| Protection                    | Class 1   |
| IP class                      | IPX4  |
| Machine washable              | Yes   |
| Intermittence                 | 10%, max 2 min / 18 min.                              |
| Output voltage                | 24 Volt DC  |
| Weight:                       |   |
| Total system                  | approx. 42 kg   |
| Red side                      | approx. 20 kg   |
| Blue side                     | approx. 20 kg   |
| Control unit (incl extension) | approx. 2 kg  |
| Battery (accessory)           | approx. 0,7 kg  |
| Length:                       | 200 - 220 cm (telescopic)                             |
| Width:                        | May be adapted to beds between<br>70 and 130 cm       |
| Expected service life         | 10 years  |
| Noise level max. load         | 55 db(A)  |
| Turning sheet:                |   |
| Regular width and length      | 270 cm / 183 cm                                       |
| Material                      | 100 % cotton  |
| Slide sheet:                  |   |
| Regular width and length      | 95 cm / 210 cm  |
| Material                      | 100% nylon  |
| System service check          | Annually  |

## Power consumption

|         | VENDLET Standard               |          |
|---------|--------------------------------|----------|
| Standby |                                | 5 Watt   |
|         | Tighten sheet (without person) | 60 Watt  |
|         | Slacken sheet                  | 15 Watt  |
|         | Moving a person at 100 kg      | 75 Watt  |
|         | Moving a person at 250 kg      | 160 Watt |
|         | Raise bars                     | 110 Watt |
|         | Lower bars                     | 65 Watt  |

## LED functionality

| LED             | Indication of operating |
|-----------------|-------------------------|
| Solid yellow    | Charging                |
| No LED Light    | Fully charged           |
| Flashing yellow | Error during charging   |

## Buzzer functionality

The buzzer will make a warning when a button on the hand control is pressed and the battery capacity is low.

## Electromagnetic Compatibility

This equipment is compliant with IEC 60601-1-2, meaning that there will be no loss of basic safety or performance to intended use due to electromagnetic disturbances.



Use of this equipment adjacent to or stacked with other equipment should be avoided as it might result in irregular operation. If such use is necessary, the equipment should be observed to verify that it is operating as intended.



Portable Radio Frequency (RF) communication equipment (including antenna cables and external antennas) should be used no closer than 30 cm (12 inches) to any part of the VENDLET Standard, including cables specified by Vendlet ApS, as it can lead to irregularities in the operation of the system.

## Environmental Conditions & Disposal

### Environmental conditions

| Operation:  |                                    |
|---|------------------------------------|
| Temperature   | 5 – 40 °C                          |
| Air humidity  | 20 – 90% at 30°C – no condensation |
| Atmospheric pressure  | 700 – 1060 hPa                     |
| Storage:  |                                    |
| Temperature   | 0 – +50 °C                         |
| Air humidity  | 20 – 90% at 30°C – no condensation |
| Atmospheric pressure  | 700 – 1060 hPa                     |
| Transport:  |                                    |
| Take the necessary precautions to protect the electric components against rough jolts, shocks etc.  |                                    |
| After transportation at low temperatures the motors in the bars might work irregularly until they have been warmed up to normal room temperature. |                                    |

### Disposal

Do not discard VENDLET Standard with general household waste. On disposal of VENDLET Standard, DHG recommends that the system be divided into individual parts and components for recycling.

The control unit and the hand control must be disposed of as electronic waste. Furthermore, it may be divided into metal waste, cable waste, electronic waste, and reusable plastic.

Turning sheets and slide sheets can be washed and handed in for recycling. However, very dirty sheets must be disposed of as combustible waste.



**This Page is Left Intentionally Blank**

**This Page is Left Intentionally Blank**

**This Page is Left Intentionally Blank**



Moving Health Forward

**PRESSURE ULCER PREVENTION**  
**SAFE MOVING & HANDLING**  
**SPECIALIST THERAPIES**  
**BATHROOM SAFETY**  
**RENTAL & SERVICE SOLUTIONS**



Direct Healthcare Group Ltd  
Withey Court, Western Industrial Estate  
Caerphilly, United Kingdom  
CF83 1BF

T: +44 (0) 800 043 0881  
F: +44 (0) 845 459 9832  
E: [info@directhealthcaregroup.com](mailto:info@directhealthcaregroup.com)

**EC** **REP**

**EU Authorised Representative, Importer, and Distributor:**

Direct Healthcare Group Sverige AB,  
Torshamnsgatan 35, SE-164 40, Kista  
Sweden  
T: +46 (0) 8 557 200

**Australian Sponsor:**

Direct Healthcare Group Pty Ltd.,  
68 Howe Street, Osborne Park,  
Western Australia 6017  
T: +61 (0) 423 852 810



LIT-00153 Issue 2  
Date: January 2025

[DHG-HEALTHCARE.COM](http://DHG-HEALTHCARE.COM)